

T-001

technical bulletin

MISCELLANEOUS ELECTRICAL TABLES AND INFORMATION

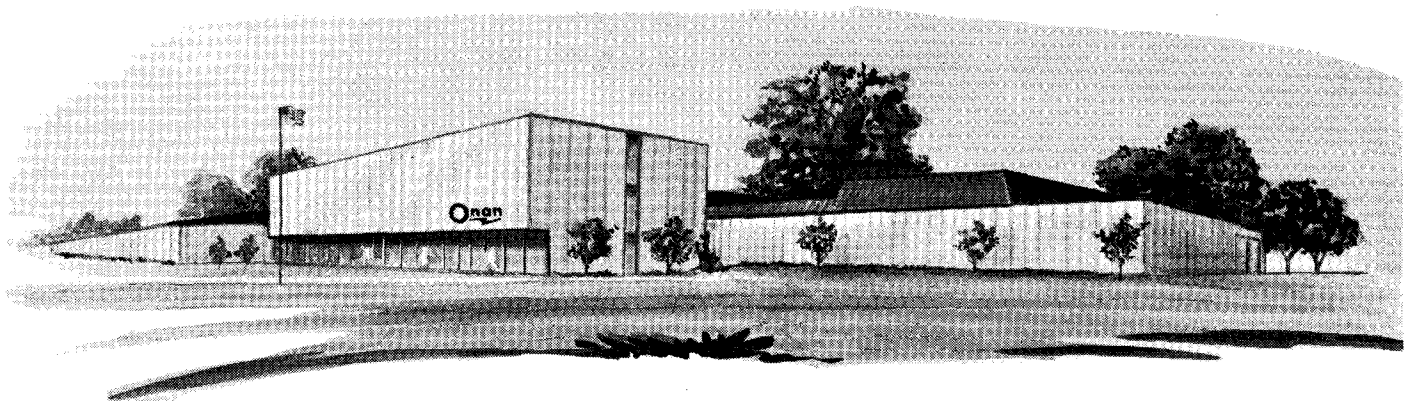

ONAN

1400 73RD AVENUE N.E. • MINNEAPOLIS, MINNESOTA 55432
A DIVISION OF ONAN CORPORATION

Printed in U.S.A.

JANUARY 1975

Introduction

Some of the material in this technical bulletin is intended to provide various electrical information for installations of Onan equipment, other material explains electrical terminology, common symbols used in wiring diagrams and schematics, etc. Characteristics of conductors, effects of voltage drops, nominal ampere ratings of AC and DC generating sets and correct wire sizes are factors to be considered for almost all installations.

Most of the information such as conductor characteristics, typical running current requirements of motors, wire sizes, has been standardized through the years and can be found in most electrical handbooks. Onan does not mean to design or restrict installations through its technical bulletins, but rather to perform as an aid. Each installation must be planned carefully, be acceptable to electrical inspectors and comply with applicable codes and regulations.

MOTOR CIRCUIT AMPERE RATING AND INTERRUPTING CAPACITY

The ampacity (current carrying capacity) of torque motor circuits and the disconnecting means (over current protection circuit breaker capacities) must be at least 115 percent of the motor nameplate capacities or a summation of all circuit currents at the full-load condition.

To determine the equivalent horsepower for the disconnecting means to be used in a circuit, select the horsepower rating or the next higher value from Table 3 which corresponds to the motor current for the voltage in use.

To determine the ampere and horsepower ratings for the disconnecting means to be used with combination loads, a summation of all currents (including resistance loads at the full-load condition) is used and considered as a single motor. The full-load current equivalent is then selected from Table 3.

The locked rotor current equivalent to the horsepower rating is selected from Table 4. For a combined load, the locked rotor current must be added to the ampere rating of the other loads in the circuit to obtain the equivalent locked rotor current. For small motors not covered by Table 3, the locked rotor current should be six times the full-load current.

For additional information, refer to the latest edition of the National Electrical Code (NFPA 70-1975) and to your local electrical code requirements.

TABLE 3. FULL-LOAD CURRENT * THREE-PHASE ALTERNATING-CURRENT MOTORS

HP	Induction Type Squirrel-Cage and Wound Rotor Amperes				Synchronous Type † Unity Power Factor Amperes		
	200V	230V	460V	575V	220V	440V	550V
1/2	2.3	2	1	.8			
3/4	3.2	2.8	1.4	1.1			
1	4.1	3.6	1.8	1.4			
1-1/2	6.0	5.2	2.6	2.1			
2	7.8	6.8	3.4	2.7			
3	11.0	9.6	4.8	3.9			
5	17.5	15.2	7.6	6.1			
7-1/2	25.3	22	11	9			
10	32	28	14	11			
15	48	42	21	17			
20	62	54	27	22			
25	78	68	34	27	54	27	22
30	92	80	40	32	65	33	26
40	119	104	52	41	86	43	35
50	150	130	65	52	108	54	44
60	177	154	77	62	128	64	51
75	221	192	96	77	161	81	65
100	285	248	124	99	211	106	85
125	359	312	156	125	264	132	106
150	414	360	180	144		158	127
200	552	480	240	192		210	168

* - These values of full-load current are for motors running at speeds usual for belted motors and motors with normal torque characteristics. Motors built for especially low speeds or high torques may require more running current, and the nameplate current rating shall be used.

† - For 90 and 80 percent power factor, the above figures shall be multiplied by 1.1 and 1.25 respectively.

The voltages listed are rated motor voltages. The currents listed shall be permitted for system voltage ranges of 110 to 120, 220 to 240, 440 to 480, and 550 to 600 volts.

MISCELLANEOUS ELECTRICAL TABLES AND INFORMATION

TABLE I. CHARACTERISTICS OF CONDUCTORS

WIRE SIZE	AREA CIRCULAR MILLS	OHMS PER 1000 FT. 25° C or 77° F.	BARE COPPER POUNDS PER 1000 FT.	ALLOWABLE AMPACITIES OF INSULATED COPPER CONDUCTORS - Based on Ambient Temperature of 30° C (86° F). For additional details, refer to the National Electrical Code (NEC) Tables 310-16 through 310-19.		
				3 Conductors or less in raceway or cable Type T, TW, or UF.	Copper conductor in free air Type T, or TW	4 through 6 in raceway or cable Type T, TW, or UF
14	4,109	2.575	12.43	15	20	12
12	6,520	1.619	19.77	20	25	16
10	10,380	1.018	31.43	30	40	24
8	16,510	.641	49.98	40	55	32
6	26,240	.410	79.46	55	80	44
4	41,740	.259	126.4	70	105	56
2	66,360	.162	205.0	95	140	76
1	83,690	.129	258.0	110	165	88
0	105,560	.102	326.0	125	195	100
00	133,080	.0811	411.0	145	225	116
000	167,770	.0642	518.0	165	260	132
0000	211,600	.0509	640.5	195	300	156

TABLE 2. TYPICAL RUNNING CURRENT REQUIREMENTS OF MOTORS AND RECOMMENDED WIRE SIZE

H.P.	115 V 1 PHASE AC		230 V 1 PHASE AC		120 VDC		240 VDC	
	A	W	A	W	A	W	A	W
1/6	4.4	14	2.2	14				
1/4	5.8	14	2.9	14	3.1	14	1.6	14
1/3	7.2	14	3.6	14	4.1	14	2.0	14
1/2	9.8	14	4.9	14	5.4	14	2.7	14
3/4	13.8	12	6.9	14	7.6	14	3.8	14
1	16.0	12	8.0	14	9.5	14	4.7	14
1-1/2	20.0	10	10.0	14	13.2	12	6.6	14
2	24	10	12.0	14	17.0	10	8.5	14
3	34	6	17.0	10	25.0	8	12.2	12
5	56	4	28.0	8	40.0	6	20.0	10
7-1/2	80	1	40.0	6	58.0	3	29.0	8
10	100	0	50.0	4	76.0	2	38.0	6

NEC 430-148

NEC 430-147

A - Full rated load current in amperes (amperes while starting are much higher).

W - Minimum wire size permitted by code; larger sizes often required - check distance for voltage drop.

**TABLE 4. LOCKED-ROTOR CURRENT CONVERSION TABLE
FOR MOTOR CIRCUITS AND CONTROLLERS**

MAX. HP RATING	Typical Motor Locked-Rotor Current Amperes						
	Single Phase		115V		Two or Three Phase		
	115V	230V	115V	200V	230V	460V	575V
1/2	58.8	29.4	24	14	12	6	4.8
3/4	82.8	41.4	33.6	19	16.8	8.4	6.6
1	96	48	42	24	21	10.8	8.4
1-1/2	120	60	60	34	30	15	12
2	144	72	78	45	39	19.8	15.6
3	204	102	—	62	54	27	24
5	336	168	—	103	90	45	36
7-1/2	480	240	—	152	132	66	54
10	600	300	—	186	162	84	66
15	—	—	—	276	240	120	96
20	—	—	—	359	312	156	126
25	—	—	—	442	384	192	156
30	—	—	—	538	468	234	186
40	—	—	—	718	624	312	246
50	—	—	—	862	750	378	300
60	—	—	—	1035	900	450	360
75	—	—	—	1276	1110	558	444
100	—	—	—	1697	1476	738	588
125	—	—	—	2139	1860	930	744
150	—	—	—	2484	2160	1080	864
200	—	—	—	3312	2880	1440	1152

**TABLE 5. *RECOMMENDED WIRE SIZE FOR
A SINGLE 3-PHASE MOTOR HORSE POWER**

Volts	1-3	5	7-1/2	10	15	20	25	30	40	50	60	75
200	14	10	8	6	4	3	1	0	000	000	300	400
230	14	12	10	8	6	4	3	1	0	000	000	300
460	14	14	14	12	10	8	6	6	4	3	2	0
575	14	14	14	14	12	10	8	6	6	4	3	2

Volts	100	125	150	200	250	300	350	400	450	500
200	600									
230	500									
460	000	0000	300	500	700	900	1500	600(1)	750(1)	900(1)
575	0	000	0000	250	500	600	800	1000	1500	600(1)

* - Branch circuit conductors supplying a single motor shall have an ampacity not less than 125 percent of the motor full load current rating.

STANDARD VOLTAGES

Direct Current:

- For charging 6-volt battery, battery voltage 6-8 volts.
- For charging 12-volt battery, battery voltage 12-14 volts.
- For charging 24-volt battery, battery voltage 24-30 volts.
- For charging 32-volt battery, battery voltage 32-40 volts.
- For charging 110-volt battery, battery voltage 110-140 volts.

- For battery-less systems, generator voltage 115.
- For battery-less systems, generator voltage 230.

Alternating Current: Usually 60-hertz in U.S.A. (In foreign countries, 50-hertz current is common).

For a more complete explanation, see technical bulletin T-005.

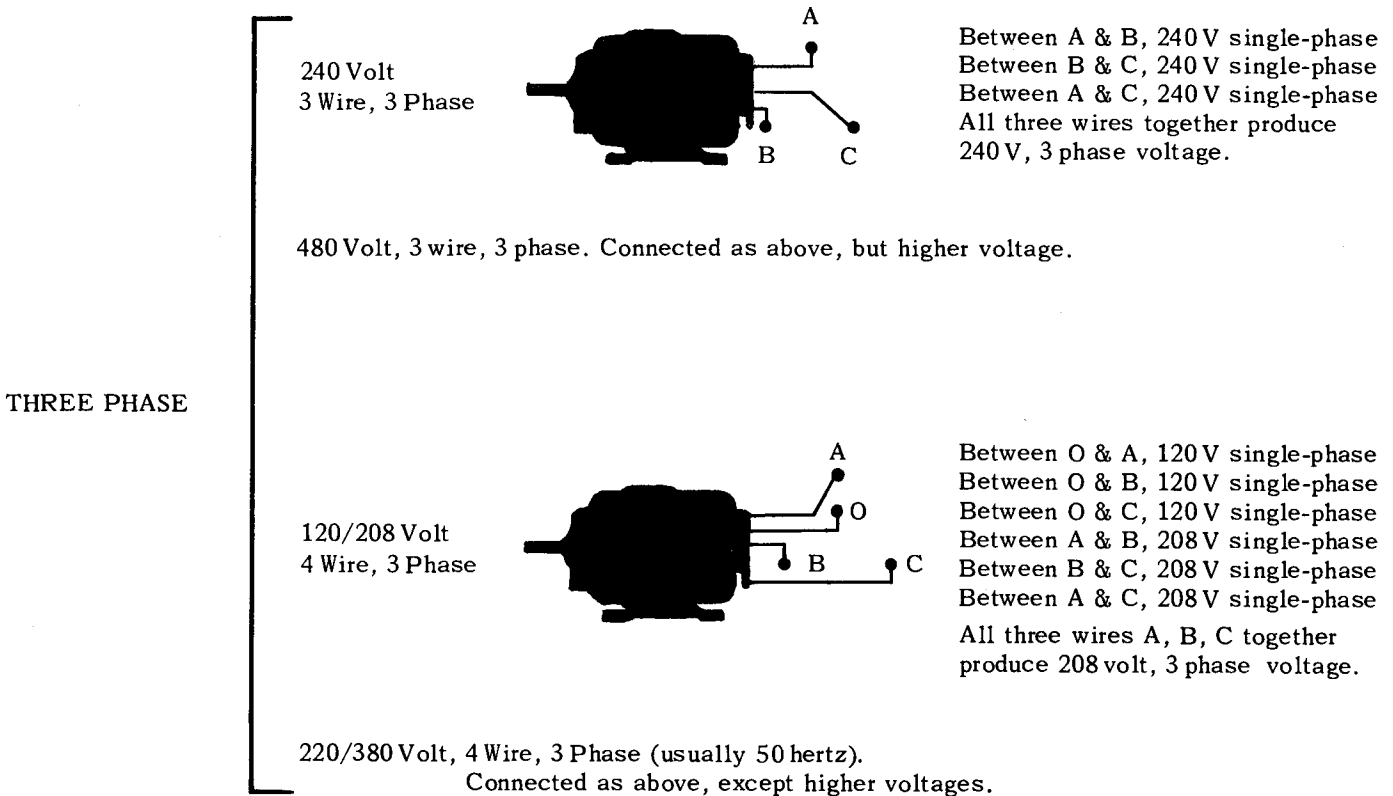
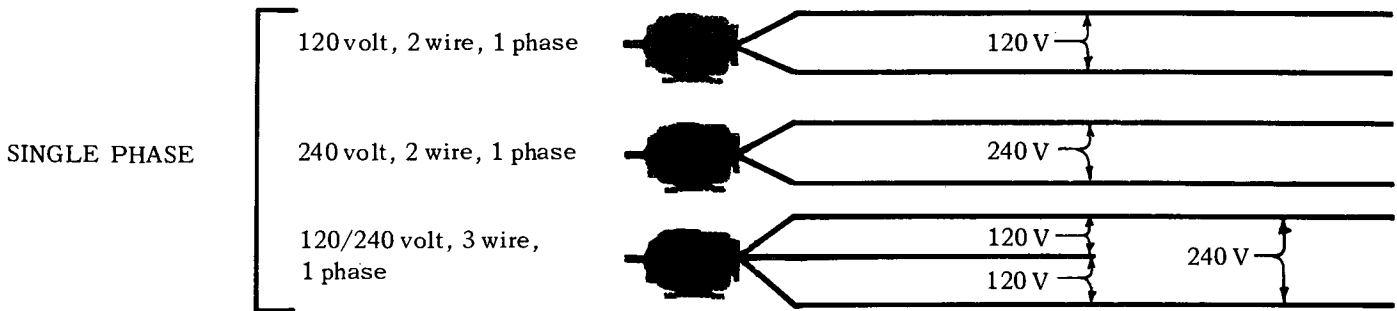

VOLTAGE DROP

A voltage drop exists in any wire carrying an electric current. It is the loss in pressure (volts) when a current (amperes) flows through a conductor which has resistance (ohms). This voltage drop is wasted electricity as it does nothing productive at the other end of the conductor. It is advisable to keep the voltage drop as low as possible to maintain the efficiency of the system. This is done by using wire of sufficient size; the larger the wire, the less the drop. See tables 5 through 9 on wire sizes.

FIGURE 1. EFFECTS OF VARYING VOLTAGE ON LIGHT PRODUCED BY BULB

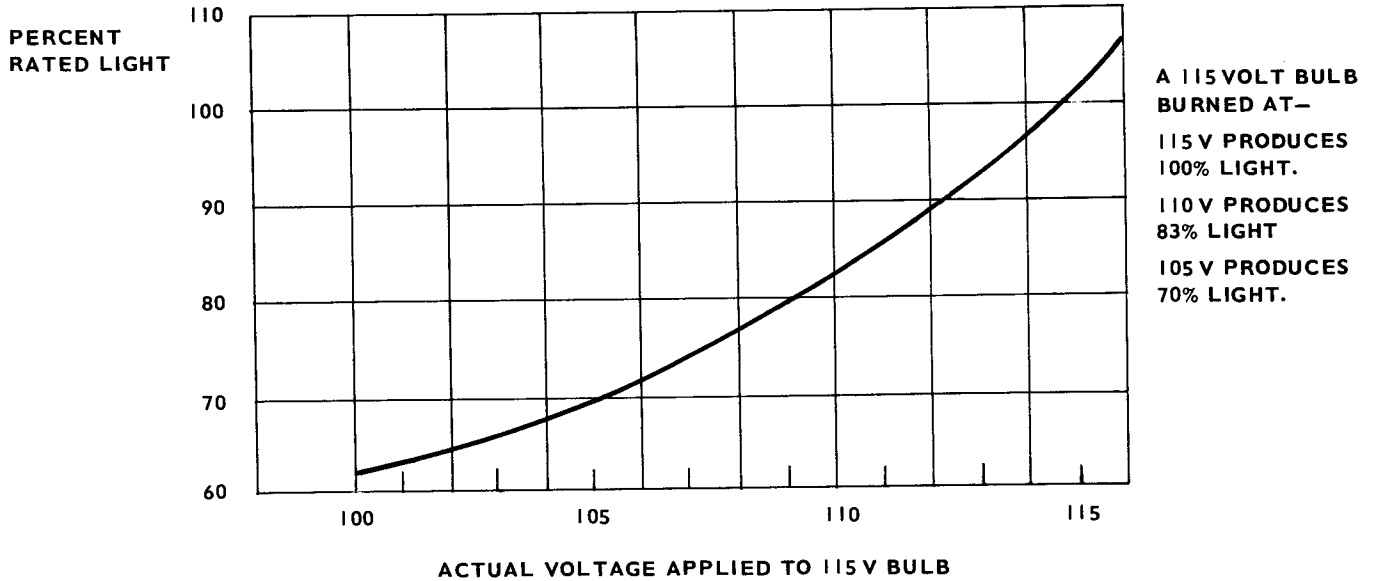
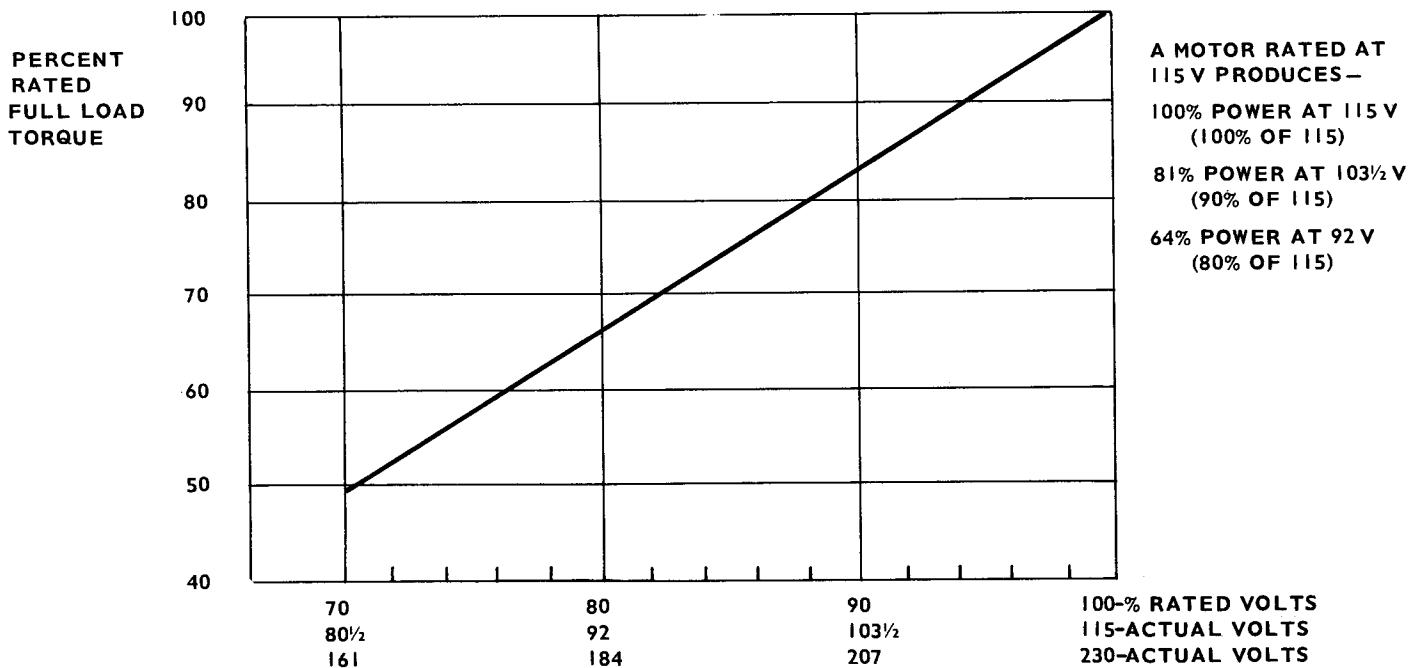

FIGURE 2. EFFECTS OF VARYING VOLTAGE ON POWER DELIVERED BY MOTOR



WIRE SIZES

Low Voltage DC Systems: Wire sizes in Tables 6, 7, 8 apply to the largest wattage available from Onan DC battery charging generating sets for that voltage. Distances are based on an allowable 4% voltage drop. If only a 2% voltage drop is allowable, cut the distances in half. None of the amperages given for the various wire lengths exceed the maximum amperage (ampacity) of that particular wire size. For other sizes, consult an electrical handbook.

TABLE 6. WIRE SIZES FOR 12-VOLT CIRCUIT WITH 4% (0.48 VOLT) VOLTAGE DROP

* WIRE SIZE		10	8	6	4	2	1
WATTS AT 12 VOLTS	AMPERES AT 12 VOLTS	**DISTANCE IN FEET					
25	2.08	105	170	275	435	695	875
50	4.17	50	85	135	215	345	435
100	8.33	25	40	65	105	170	215
150	12.50	15	25	45	70	115	145
200	16.67	--	20	30	50	85	105
250	20.83	--	15	25	40	65	85
300	25.00	--	--	20	35	55	70
400	33.33	--	--	15	25	40	50
500	41.67	--	--	--	20	30	40
600	50.00	--	--	--	15	25	35

* - Minimum wire size recommended is number 10.

** - One-way distance for a 2-wire run.

TABLE 7. WIRE SIZES FOR 24-VOLT CIRCUIT WITH 4% (0.96) VOLTAGE DROP

* WIRE SIZE		12	10	8	6	4	2	1
WATTS AT 24 VOLTS	AMPERES AT 24 VOLTS	**DISTANCE IN FEET						
50	2.08	135	215	345	550	875	1390	1755
100	4.17	65	105	170	270	435	690	875
150	6.25	45	70	115	180	290	460	580
200	8.33	30	50	85	135	215	345	435
250	10.42	25	40	65	105	170	275	350
300	12.50	20	35	55	90	145	230	290
400	16.67	--	27	30	65	105	170	215
500	20.83	--	20	25	50	85	135	175
600	25.00	--	--	20	45	70	115	145
800	33.33	--	--	--	30	50	85	105
1000	41.67	--	--	--	25	40	65	85
1200	50.00	--	--	--	20	35	55	70
1400	58.33	--	--	--	--	30	50	60
1500	62.50	--	--	--	--	25	45	55

* - Minimum wire size recommended is number 12.

** - One-way distance for a 2-wire run.

TABLE 8. WIRE SIZES FOR 32-VOLT CIRCUIT WITH 4% (1.28 VOLT) VOLTAGE DROP

* WIRE SIZE		12	10	8	6	4	2
WATTS AT 32 VOLTS	AMPERES AT 32 VOLTS	**DISTANCE IN FEET					
50	1.56	240	385	615	975	1555	2475
100	3.13	120	190	305	485	775	1230
150	4.69	80	125	200	325	515	820
200	6.25	60	95	150	240	385	615
250	7.81	45	75	120	195	310	490
300	9.38	40	60	100	160	255	410
400	12.50	30	45	75	120	190	305
500	15.63	20	35	60	95	155	245
600	18.75	--	30	50	80	125	205
800	25.00	--	20	35	60	95	150
1000	31.25	--	--	30	45	75	120
1200	37.50	--	--	25	40	60	100
1400	43.85	--	--	--	35	55	85
1500	46.88	--	--	--	30	50	80

* - Minimum wire size recommended is number 12.

** - One-way distance for a 2-wire run.

TABLE 9. WIRE SIZES FOR 120 VOLT DC OR AC, UNITY POWER FACTOR, 2% VOLTAGE DROP (2.4 VOLTS)

WIRE SIZE		14	12	10	8	6	4	2
WATTS *	AMPERES AT 120 VOLTS	* DISTANCE (FEET)						
	.84	550	880	1330	2080	3400	5500	8500
	1.67	275	440	665	1060	1690	2750	4300
	2.50	183	290	450	710	1130	1850	2840
	3.33	137	220	330	530	840	1380	2150
500	4.16	110	175	265	430	680	1100	1700
750	6.25	73	115	177	285	450	740	1140
1000	8.33	55	83	130	214	340	550	850
1500	12.50	36	57	88	146	225	365	575
2000	16.66	27	42	68	104	166	275	430
2500	20.80	22	37	52	83	135	220	365
3000	25.00	18	26	42	68	115	188	285
3500	29.20	--	23	37	63	94	155	245
4000	33.30	--	21	31	52	83	134	217
4500	37.50	--	15	29	46	73	119	176
5000	41.80	--	--	26	42	67	108	166
6000	50.00	--	--	21	36	57	88	140
7000	58.30	--	--	--	29	46	78	119
8000	66.60	--	--	--	26	42	67	104
9000	75.00	--	--	--	--	36	57	93
10000	83.30	--	--	--	--	31	52	83

* - Above figures represent a one-way distance in feet for a 2-wire run. If a 4% voltage drop is permissible, double the distances listed.

* - For other voltages (120, 240, etc.), use amperes column - disregard watts. If only 1% voltage drop is allowable, divide the distances listed by 2.

AC, Single Phase: For 120 volt - use Table 9; 120/240 volt, 3 wire - use Table 9 for each 120-volt circuit; 240 volt - use watts column in Table 9, multiply distances by 4 or use amperes column and multiply distances by 2; 480-volt circuit, use watts column in Table 9 and multiply distances by 16 or use amperes column and multiply distances by 4.

AC, Three-Phase Systems: For a 240-volt circuit, multiply the distances in the 120-volt Table 9 by 4 for a load of the number of amperes indicated. Use the amperes column. For a 480-volt circuit, multiply the distances in the 120-volt Table 9 by 8 for the same load. Use the amperes column.

Formula for Determining Wire Size Under Any Other Condition:

A. Direct-current and single-phase systems:

$$CM = \frac{D \times I \times 22}{Ed}$$

B. Three-phase, three-wire systems:

$$CM = \frac{D \times I \times 19}{Ed}$$

CM = circular mills - Wire Size (see Table 1)

I = current in amperes (In the case of three phase, it is the current in each wire.)

D = single distance on one way length of the circuit in feet.

Ed = allowable voltage drop in volts (2% of 115 volts is 2.3 volt, etc.)

Shown below are the diameters of the various wire sizes without the insulation.

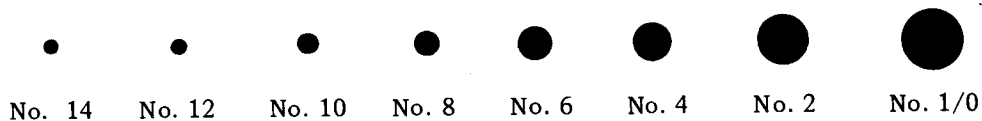

DEFINITIONS

Ampacity: Current carrying capacity of electric conductors expressed in amperes.

Alternating Current: Alternating current (AC) is current which reverses direction rapidly, flowing back and forth in the system with regularity. This reversal of current is due to reversal of voltage which occurs at the same frequency. In alternating current, any one wire is first positive, then negative, then positive and so on. With commercial power, the change from positive to negative to positive occurs 60 times per second resulting in 60 hertz current.

Alternator: An electric generator designed to supply alternating current. Some types have a revolving armature and in other types a revolving field.

Ampere: The ampere is the unit of measurement for electric current. It represents the rate at which current flows through a resistance of one ohm by a pressure of one volt.

Capacitor or Condenser: A capacitor is an electrical device which causes the current to lead the voltage, opposite in effect to inductive reactance. Capacitors are used to neutralize the objectional effect of lagging current (inductive reactance) which overloads the power source. It also acts as a low resistance path to ground for currents of radio frequency thus effectively reducing radio disturbance.

Conductor: Substances which offer little resistance to the flow of electric current (such as metals). Silver, copper, and aluminum are especially good conductors although no material is a perfect conductor. Each of the wires lying in the armature slots of an electric generator is referred to as a conductor.

Current: The flow of electricity in a circuit (similar to the flow of water in a pipe). It is expressed in amperes and represents an amount of electricity, similar to gallons per minute of water flow, regardless of the pressure (voltage).

Cycle: One complete period of flow of alternating current in both directions. One cycle represents 360°. See *Frequency*.

Direct Current: Current (DC) which flows in one direction only. One wire is always positive, the other negative.

Electrical Generator: An electrical generator is a machine so constructed that when its rotor is driven by an engine or other prime mover, a voltage is generated.

Exciter: An exciter is a direct-current generator which supplies direct current to excite or magnetize the fields of an alternator. An exciter may be a separate machine or be combined with the alternator.

Farad: The farad is a measure of electrical capacity of condensers. A microfarad is one-millionth of a farad and is abbreviated "mfd".

Frequency: Frequency of alternating current is the number of cycles per second. A 60-hertz alternating current makes 60 complete cycles of flow back and forth (120 alternations) per second. A conventional alternator has an even number of field poles arranged in alternate north and south polarities.

Current flows in one direction in an AC armature conductor while the conductor is passing a north pole and in the other direction while passing a south pole. The conductor passes two poles during each cycle. A frequency of 60 hertz requires the conductor to pass 120 poles per second. In a 6-pole alternator, the equivalent speed would be 20 revolutions per second or 1200 revolutions per minute. In a 4-pole alternator, the equivalent speed would be 30 revolutions per second or 1800 revolutions per minute.

Hertz: A unit of frequency, one cycle per second. Written as 50-hertz or 60-hertz current, etc.

Impedance: Effects placed on alternating current by inductive capacitance (current lags voltage), capacitive reactance (current leads voltage) and resistance (opposes current but doesn't lag or lead voltage) or any combination of two. It's measured in ohms like resistance.

Insulator: Substances which offer great resistances to the flow of electric current such as glass, porcelain, paper, cotton, enamel and paraffin are called insulators because they are practically non-conducting. However, no material is a perfect insulator.

KVA: The abbreviation of kilovolt-amperes which is the product of the volts times the amperes divided by 1000. This term is used in rating alternating current machinery because with alternating currents, the product of the volts times the amperes usually does not give the true average power. See *Reactance* and *Power Factor*.

KVAR: The abbreviation of kilovolt-ampere reactance which is a measurement of reactive power that generates power within induction equipment (motors, transformers, holding coils, lighting ballasts, etc.).

KW: The abbreviation for kilowatt which is a unit of measurement of electrical power. A kilowatt (KW) equals 1000 watts and is the product of the volts times the amperes divided by 1000 when used in rating direct current machinery. It is also the term used to indicate true power in an AC circuit.

Kilowatt Hour: A kilowatt hour is the amount of electrical power represented by 1000 watts for a period of 1 hour. Thus a generator which delivered 1000 watts for a period of 1 hour would have delivered 1 kilowatt hour of electricity.

Ohm: The ohm is the unit of measurement of electrical resistance and represents the amount of resistance that permits current to flow at the rate of one ampere under a pressure of one volt. The resistance (in ohms) equals the pressure (in volts) divided by the current (in amperes).

Power Factor: When the current waves in an alternating-current circuit coincide exactly in time with the voltage waves, the product of volts times amperes gives volt amperes which is true power in watts (or in KW if divided by 1000). When the current waves lag behind the voltage, due to inductive reactance (or lead due to capacitive reactance), they do not reach their respective peak values at the same time. Under such conditions, the product of volts and amperes does not give true average watts. Such a product is called volt amperes or apparent watts. The factor by which apparent watts must be multiplied to give the true watts is known as the power factor (PF).

Power factor depends on the amount of lag or lead, and is the percentage of apparent watts which represents true watts. With a power factor of 80%, a fully loaded 5KVA (80% PF) alternator will produce 4KW (true watts). When the rating of a power unit is stated in KVA at 80% PF, it means that with an 80% PF load, the generator will generate its rated voltage providing the load does not exceed the KVA rating.

An engine-driven alternator with automatic voltage regulation, the KVA rating usually is determined by the maximum current which can flow through the windings without injurious overheating or by the ability of the engine or other prime mover to maintain the normal operating speed. A resistance load such as lamp bulbs, irons, toasters and similar devices is a unity power factor load. Motors, transformers and various other devices cause a current wave lag which is expressed in the power factor of the load.

Reactance: Reactance is opposition to the change of current flow in an AC circuit. The rapid reversing of alternating current tends to induce voltages that oppose the flow of current in such a manner that the current waves do not coincide in time with the voltage waves. The opposition of self inductance to the flow of current is called "inductive reactance" and causes the current to lag behind the voltage which produces it. The

opposition of a condenser or of capacitance to the change of alternating current voltage causes the current wave to lead the voltage wave. This is called "capacitive reactance." The unit of measurement for either inductive reactance or capacitive reactance is the ohm.

Resistance: Electrical resistance is opposition to the flow of electric current and may be compared to the resistance of a pipe to the flow of water. All substances have some resistance but the amount varies with different substances and with the same substances under different conditions.

Resistor: A resistor is a poor conductor used in a circuit to create resistance which limits the amount of current flow. It may be compared to a valve in a water system.

See technical bulletin T-005 on phase.

Single Phase: A single phase, alternating-current system has a single voltage in which voltage reversals occur at the same time and are of the same alternating polarity throughout the system.

Three Phase: A three phase, alternating-current system has three individual circuits or phase. Each phase is timed so the current alternations of the first phase is 1/3 cycle (120°) ahead of the second and 2/3 cycle (240°) ahead of the third.

Voltage: Voltage is the force, pressure or electromotive force (EMF) which causes electric current to flow in an electric circuit. Its unit of measurement is the volt, which represents the amount of electrical pressure that causes current to flow at the rate of one ampere through a resistance of one ohm. Voltage in an electric circuit may be considered as being similar to water pressure in a pipe or water system.

Voltage Drop: The voltage drop in an electrical circuit is the difference between the voltage at the power source and the voltage at the point at which electricity is to be used. The voltage drop or loss is created by the resistance of the connecting conductors.

Watt: The watt is the unit of measurement of electrical power or rate of work. 746 watts is equivalent to 1 horsepower. The watt represents the rate at which power is expended when a pressure of one volt causes current to flow at the rate of one ampere. In a DC circuit or in an AC circuit at unity (100%) power factor, the number of watts equals the pressure (in volts) multiplied by the current (in amperes).

ELECTRICAL FORMULAS FOR DETERMINING WATTS, KILOWATTS, AMPERES, KILOVOLT-AMPERES AND HORSEPOWER

(NEW SYMBOLS)

<u>FACTOR</u>	<u>ALTERNATING CURRENT</u>	<u>DIRECT CURRENT</u>
Watts	A x V x PF (1-phase) A x V x 1.73 x PF (3-phase)	A x V
Kilowatts	$\frac{A \times V \times PF}{1000}$ (1-phase) $\frac{A \times V \times 1.73 \times PF}{1000}$ (3-phase)	$\frac{A \times V}{1000}$
Amperes	$\frac{kW \times 1000}{V \times PF}$	$\frac{kW \times 1000}{V}$
Kilovolt-amperes (kVA)	$\frac{A \times V}{1000}$ (1-phase) $\frac{A \times V \times 1.73}{1000}$ (3-phase)	_____
Frequency (hertz) Hz	$\frac{P \times RPM}{120}$	_____
Revolutions per minute	$\frac{Hz \times 120}{P}$	_____
Number of poles	$\frac{Hz \times 120}{RPM}$	_____
Power factor	$\frac{\text{Actual watts}}{A \times V}$	_____
Horsepower (kilowatts)	$\frac{A \times V \times PF}{746-W \times \% \text{ Eff}}$	$\frac{A \times V}{746 \times \% \text{ Eff}}$
Amperes when kilowatts is known	$\frac{kW \times 1000}{V \times PF}$	$\frac{kW \times 1000}{V}$
Amperes when kilovolt- amperes is known	$\frac{kVA \times 1000}{V}$	_____
Amperes when horsepower is known	$\frac{kW \times \% \text{ Eff}}{V \times PF}$	$\frac{kW \times \% \text{ Eff}}{V}$
Voltage tolerance	% = $\frac{\text{No-load—Full-load voltage}}{2 \times \text{rated voltage}} \times 100$	
Voltage regulation	% = $\frac{\text{No-load—Full-load voltage}}{\text{Full load volts}} \times 100$	
Voltage drop	V = A X Ω	V = A x R (Ω)
Speed regulation	% = $\frac{\text{No-load—Full-load}}{\text{Full load speed}} \times 100$	

**ELECTRICAL FORMULAS FOR DETERMINING WATTS, KILOWATTS,
AMPERES, KILOVOLT-AMPERES AND HORSEPOWER**

(OLD SYMBOLS)

	ALTERNATING CURRENT	DIRECT CURRENT
Watts	$I \times E \times PF$ (single phase) $I \times E \times 1.73 \times PF$ (3 phase)	$I \times E$
Kilowatts	$\frac{I \times E \times PF}{1000}$ (single phase) $\frac{I \times E \times 1.73 \times PF}{1000}$ (3 phase)	$\frac{I \times E}{1000}$
Amperes	$\frac{KW \times 1000}{E \times PF}$	$\frac{KW \times 1000}{E}$
Kilovolt - amperes (KVA)	$\frac{I \times E}{1000}$ (single phase) $\frac{I \times E \times 1.73}{1000}$ (3 phase)	_____
Frequency (hertz)	$\frac{P \times RPM}{120}$	_____
Revolutions per minute	$\frac{F \times 120}{P}$	_____
Number of poles	$\frac{F \times 120}{RPM}$	_____
Power factor	$\frac{\text{Actual watts}}{I \times E}$	_____
Horsepower	$\frac{I \times E \times PF}{746 \times \% \text{ Eff}}$	$\frac{I \times E}{746 \times \% \text{ Eff}}$
Amperes when kilowatts is known	$\frac{KW \times 1000}{E \times PF}$	$\frac{KW \times 1000}{E}$
Amperes when kilovolt- amperes is known	$\frac{KVA \times 1000}{E}$	_____
Amperes when horsepower is known	$\frac{HP \times 746 \times \% \text{ Eff}}{E \times PF}$	$\frac{HP \times 746 \times \% \text{ Eff}}{E}$
Voltage tolerance	$\% = \frac{\text{No-load} - \text{Full-load voltage}}{2 \times \text{rated voltage}} \times 100$	
Voltage regulation	$\% = \frac{\text{No-load} - \text{Full-load voltage}}{\text{Full load volts}} \times 100$	
Voltage drop	$E = I \times R$	$E = I \times R$
Speed regulation	$\% = \frac{\text{No-load} - \text{Full-load}}{\text{Full load speed}} \times 100$	

OHM'S LAW: Ohm's law states that the current in an electric circuit is equal to the pressure divided by the resistance.

The equations may be written:

OHM 'S LAW:

$$A = \frac{V}{\Omega} \quad \text{Amperes} = \frac{\text{Volts}}{\text{Ohms}}$$

$$V = A \Omega \quad \text{Volts} = \text{Amperes} \times \text{Ohms}$$

$$\Omega = \frac{V}{A} \quad \text{Ohms} = \frac{\text{Volts}}{\text{Amperes}}$$

OLD	FACTOR	NEW
E	volts	V
F	frequency	Hz
P	watts.....	W
HP.....	horsepower	kW
I.....	amperes	A
R	resistance (ohms)	Ω
Z	impedance (ohms).....	AC Ω
KW	kilowatts	kW
KVA	kilovolt amperes	kVA
P	number of poles	P
PF	power factor	PF
RPM	revolutions per minute ...	RPM
%Eff	percent efficiency	%Eff

NOTE: See nominal ampere ratings of AC and DC units at the end of this bulletin.

ELECTRICAL SYMBOLS

A graphic symbol represents the function of a part in the circuit. They are used on schematic diagrams and wiring diagrams. They are correlated with parts lists, descriptions and instructions.

A schematic diagram shows, by means of graphic symbols, the electrical connections and functions of a specific circuit arrangement. It aids tracing the circuit and its functions without regard to the actual physical size, shape or location of the component device or parts.

A wiring diagram is used for wiring and tracing out the connection in the circuit. The placement of parts or assemblies shall usually show the general physical arrangement of the control. It may cover internal or external connections or both.

The standard symbol for a terminal (○) may be added to each point of attachment to the connecting lines to any one of the symbols.

The polarity symbol, + for positive, - for negative, is used as necessary and if clarity is required to understand a circuit function.

The ground symbol \perp is a direct conducting connection to the earth or body of water or a conducting connection to a structure that serves as an earth ground (such as the frame of an air, space, or land vehicle).

For simplification of a schematic diagram, parts of a symbol for a device such as a relay, or contactor may be separated. If this is done, suitable designations are used to show proper relationship of the parts.

LIST OF SYMBOLS

A

ASSEMBLY, SUBASSEMBLY

It is an assembly of items that is mounted and prewired as a unit, which can not be identified in a specific group or which may contain items made up of other parts.

AR

AMPLIFIER

B

MOTOR

1. General (fan, blower)

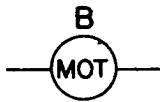

2. Series Field



3. Application: Engine Starting Motor

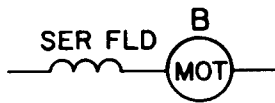

BT

BATTERY

The long line is always positive, polarity must be identified in addition (shown as multicell).

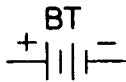

C

CAPACITOR

If it is necessary to identify the capacitor electrodes, the curved element shall represent the outside electrode in fixed paper-dielectric and ceramic dielectric capacitors, and the low potential element in feed through capacitor.

1. General

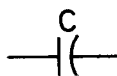

2. Polarized, Electrolytic Capacitor

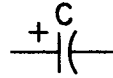

3. Feed-through Capacitor (with terminals shown on feed-through element for clarity.)

Commonly used for bypassing high frequency current to chassis.



CB

CIRCUIT BREAKER

1. General

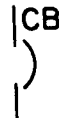

old drawings)

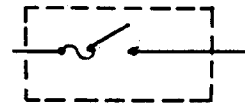

2. Circuit Breaker with thermal overload device.

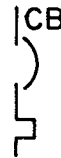

3. Circuit Breaker with magnetic overload device.



4. Circuit Breaker with thermal magnetic overload device.



5. Application: 3-pole circuit breaker with thermal magnetic overload device in each pole and trip coil (shown with boundary lines)

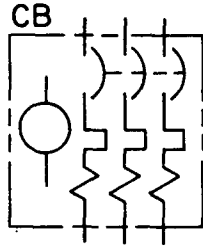

CR

RECTIFIER, DIODE

Triangle points in direction in which rectifier conducts current easily.

1. Diode, Metallic Rectifier, Electrolytic Rectifier, Asymmetrical Varistor.



2. Application: Full-Wave Bridge Type Rectifier.

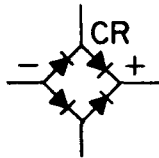

3. Controlled Rectifier (SCR)



4. Bidirectional Diode (Suppressor)

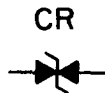

5. Zener Diode

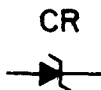

6. Tunnel Diode

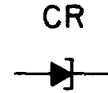

CT

CURRENT TRANSFORMER

1. General



2. Current Transformer with polarity marking.

Instantaneous direction of current into one polarity mark corresponds to current out of the other polarity mark.

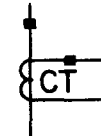

DS

SIGNALING DEVICE except meter or thermometer.

1. Audible Signaling device.

1.1 bell

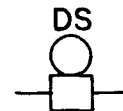

1.2. buzzer



1.3. howler



2. Visual Signaling Device (indicating, pilot, signal or illuminating lamp)

2.1. incandescent lamp



2.2: neon lamp

2.2.1 alternating-current type

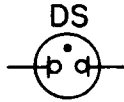

2.2.2. direct-current type

NOTE: Polarity mark is not part of the symbol.

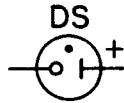

E

ELECTRICAL SHIELDING, PERMANENT MAGNET, SPARK PLUG, MISCELLANEOUS ELECTRICAL PARTS.

1. Electrical shield (short dashes) normally used for electric or magnetic shielding. When used for other shielding, a note should so indicate.

2. Permanent magnet



3. Spark plug



4. Miscellaneous Electrical part

4.1. engine choke

4.1.1. thermal

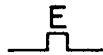

4.1.2. magnetic

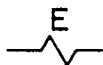

4.1.3. thermal magnetic

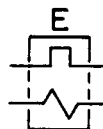

4.2. fuel pump

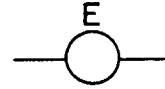

4.3 sending units (oil, water, etc.)

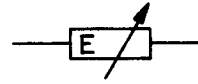

F

FUSE

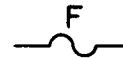

G

GENERATORS

1. General

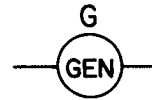

2. Field, Generator

2.1. compensating or commutating



2.2 series



2.3. shunt or separately excited.



3. Winding Symbols

3.1. 1-Phase



3.2. 3-Phase wye



(old drawings

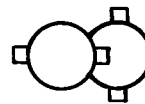

Indicates slip rings or collector rings.)

3.3 3-Phase delta



4. Application: charger generator and cranker.

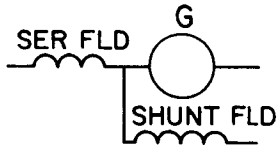

5. Application: revolving armature generator (shown as single phase, 3 wire)

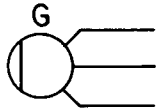

6. Application: revolving field generator (shown as 3-phase wye, 4 wire)

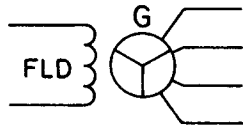

7. Application: Magneto

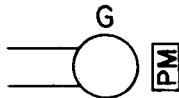

H

HARDWARE (bolts, nuts, screws, etc.) if applicable.

HR

HEATER, manifold, glow plug, general.



J

RECEPTACLE-fixed or stationary connector.

The connector symbol is not an arrow head. It is larger and the lines are drawn at a 90° angle.

1. Female Contact

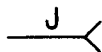

2. Male contact

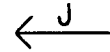

3. Application: 4-conductor connector with 3-male contacts and 1-female contact with individual contact designations.

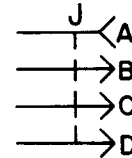

or

if no confusion results from its use by disregarding the type of contacts in the receptacle, it may be shown as

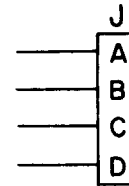

4. Receptacles of the type commonly used for power-supply purposes (convenience outlets)

4.1. female contact



4.2. male contact



5. Application: 3-conductor polarized connector with female contacts.

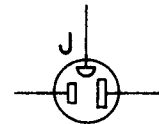

6. Application: 3-conductor polarized connector with male contacts.

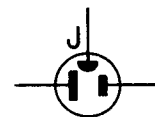

K
RELAY, CONTACTOR, SOLENOID (electrically or thermally operated)

1. Coil
- 1.1. basic operating

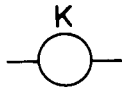

- 1.2. time delay

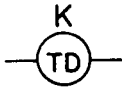

2. Contacts

2.1. basic contact assemblies

- 2.1.1. closed contact (break)

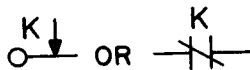

- 2.1.2. open contact (make)

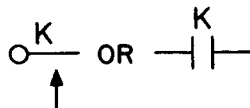

- 2.1.3 transfer

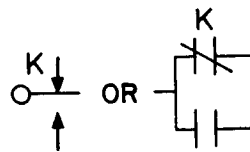

2.2. contacts with time delay feature.

- 2.2.1. closed contact, time delay opening

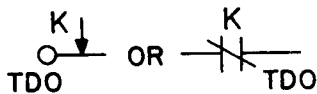

- 2.2.2. open contact, time delay closing

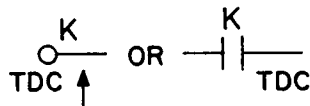

- 2.2.3 closed contact, time delay closing

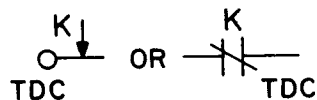

- 2.2.4 open contact, time delay opening

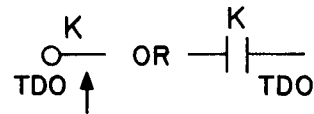

3. Application: Relay with transfer contacts

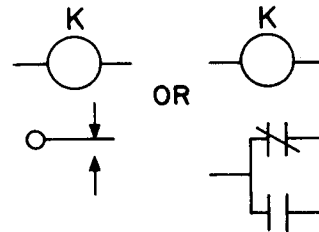

L
INDUCTOR, REACTOR

1. Air core



2. Iron Core (if desired to distinguish magnetic-core inductors)

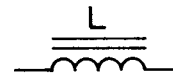

3. Saturating core

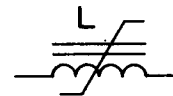

4. Saturable-core inductor (reactor)

NOTE: explanatory words & arrow are not part of the symbol shown

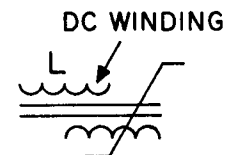

M
METERS, GAUGES, CLOCKS with calibrated dials

1. clock, electric timer
- 1.1. motor

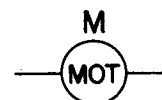

Note: contacts at left are for wiring diagrams. Contacts at right for schematic diagrams & wiring diagrams of contactors.

1.2. transfer contacts

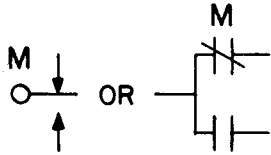

2. Indicating meters, gauges, etc.



*replace the asterisk by one of the following letter combinations, depending on the function of the meter.

- A Ammeter
- AH Ampere-hour
- F Frequency meter
- MA Milliammeter
- OP Oil Pressure
- PF Power Factor
- T Temperature
- TT Total Time (Running Time)
- V Voltmeter
- W Wattmeter
- WH Watthour meter

MP

MECHANICAL PARTS including nameplates - if applicable

P

PLUG- affixed to a cable, cord or wire

The connector symbol is not an arrowhead. It is larger and the lines are drawn at a 90° angle.

1. Female contact



2. Male contact



3. Application: 4-conductor connector with 3-male contacts and 1-female contact with individual contact designations.

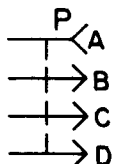

or

if no confusion results from its use by disregarding the type of contacts in the plug, it may be shown as

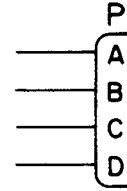

4. Plugs of the type commonly used for power-supply purposes (mating connectors)

4.1. female contact



4.2. male contact



5. Application: 3-conductor polarized connector with female contacts.

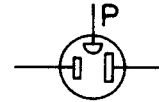

6. Application: 3-conductor polarized connector with male contacts

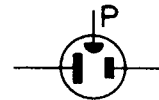

Q

TRANSISTOR

1. General

1.1. NPN

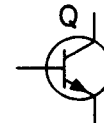

1.2. PNP

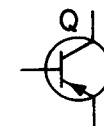

2. Unijunction

2.1. N-type base



2.2. P-type base

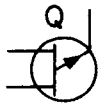

3. Field-effect

3.1. N-type base

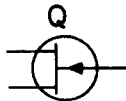

3.2. P-type base

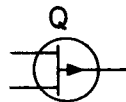

R

RESISTOR

do not use both styles of symbols on the same diagram

1. General (fixed)

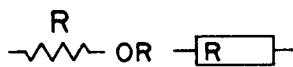

2. Tapped

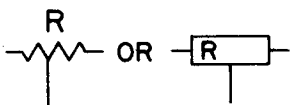

3. Adjustable contact

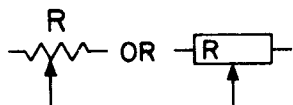

4. Rotary type adjustable

The preferred method of terminal identification is to designate with the letters "CW" the terminal adjacent to

the movable contact when it is in an extreme clockwise position as viewed from the knob end.

Rheostat

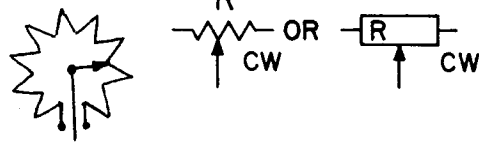

5. Non linear

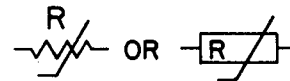

RT

THERMISTOR; THERMAL RESISTOR

"T" indicates that the primary characteristic of the element within the circle is a function of temperature

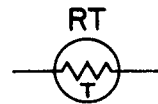

VARISTOR, SYMMETRICAL

resistor, voltage sensitive (silicon carbide, etc)

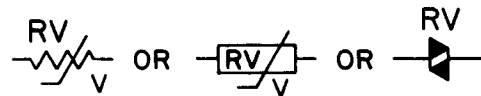

S

SWITCH

1. Thermal cutout, thermal flasher

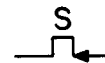

2. Switch

2.1. momentary-fixed contact on momentary switch



2.1.1. open contact (make) (ignition points)



2.1.2. closed contact (break)



2.1.3. 2-open contacts (make)

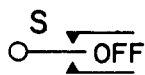

2.1.4. push button, open contact (make)

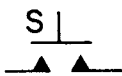

2.1.5. push button, closed contact (break)



2.2. locking or maintained-fixed contact for maintained switch.



2.2.1 open contact (make)



2.2.2. closed contact (break)



2.2.3. 2-open contact (make)

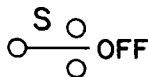

2.3. application: 3-position, 1-pole; circuit closing (make), off, momentary circuit closing (make).

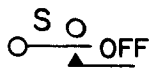

2.4. application: 2-position, 1-pole; momentary circuit closing (make), circuit closing.



2.5. selector switch

2.5.1. 4-position with non-shorting contacts

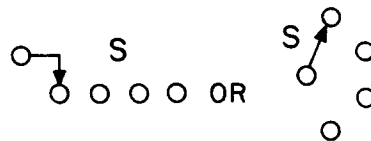

2.5.2. 4-position with shorting contacts

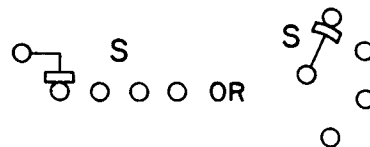

2.6. master or control switch

A table of contact operation must be shown on the diagram. A typical table is shown below.

DETACHED CONTACTS SHOWN ELSEWHERE ON DIAGRAM

CONTACT	POSITION		
	A	B	C
1 - 2			X
3 - 4	X		
5 - 6			X
7 - 8	X		

X indicates contact closed

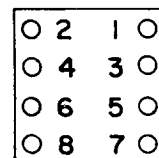

FOR WIRING DIAGRAM

2.7. flow actuated switch

2.7.1. closing on increase in flow

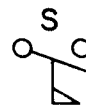

2.7.2. opening on increase in flow



2.8. liquid level actuated switch

2.8.1 closing on rising level

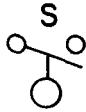

2.8.2 open on rising level

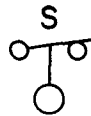

2.9. temperature actuated switch
(thermostat)

2.9.1. closing on rising temperature



2.9.2 opening on rising temperature



2.10. pressure or vacuum actuated switch

2.10.1. closing on rising pressure



2.10.2 opening on rising pressure

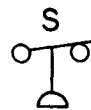

2.11. centrifugal actuated switch (overspeed)

2.11.1. closing on speed

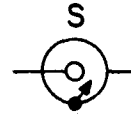

2.11.2. opening on speed

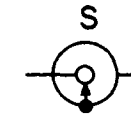

T

TRANSFORMER - ignition coil

1. Iron core



2. Air core

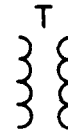

TB

TERMINAL BLOCK-MARKER STRIP

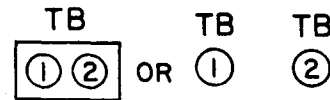

TC

THERMOCOUPLE



VR

VOLTAGE REGULATOR, CHARGE, CURRENT

W

CONDUCTORS, CABLE, WIRING,
BUSBAR, ETC.

1. Conductive path or conductor; wire



2. Two conductors or conductive paths

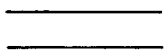

3. Three conductors or conductive paths

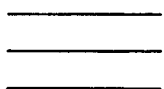

4. Crossing of paths or conductors not connected. The crossing is not necessarily at a 90° angle.

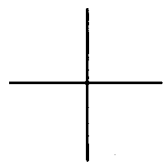

5. Splice



6. Junction of connected paths, conductors, or wires (other than a terminal)

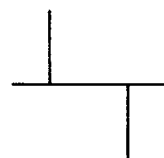

7. Terminal

may be added to each point of attachment to the connecting lines to any one of the graphic symbols.



8. Shielded single conductor

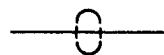

9. Shielded 2-conductor cable with shield grounded

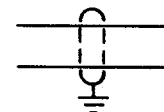

10. 2-conductor cable

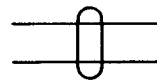

11. Grouping of leads

Normally, bend of line indicates direction of conductor joining cable



OR



12. Associated or future (short dashes)



X

FUSEHOLDER, SOCKET, LAMPHOLDER

Z

NETWORK, General

Where specific letters do not fit, when considered a part.

TYPICAL SYMBOL APPLICATIONS

GENERATOR WINDING DIAGRAM

SINGLE PHASE (SHOWN AS CODE 3)

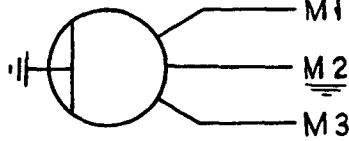

3 PHASE WYE (UNGROUNDING)

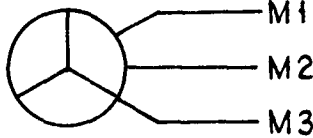

3 PHASE WYE (GROUNDED)
(SHOWN AS CODE 4)

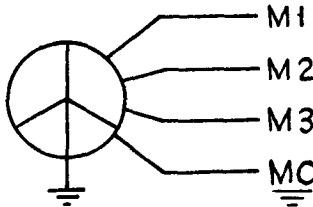

GENERATOR WINDING DIAGRAM

1-PHASE

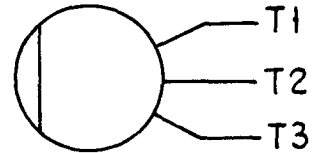

3-PHASE WYE

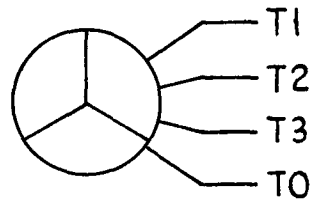

3 PHASE DELTA

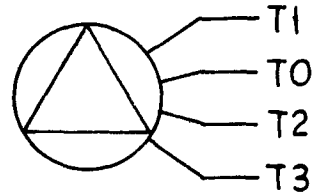

revolving field generators (AC Output)

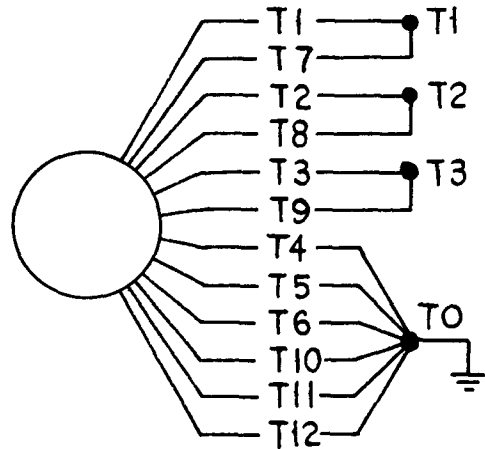
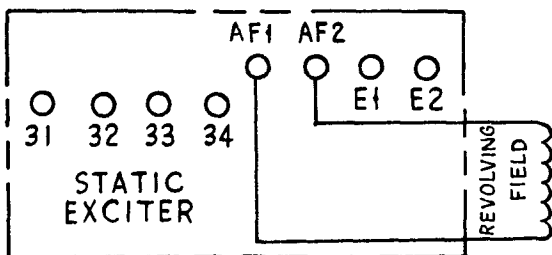

12 lead reconnectable shown connected for 120/208 V, 3 PH, 4 W. leadwire order may be changed according to specific output.

RECONNECTION BLOCK 120/240V. 1-Phase, 4-Wire

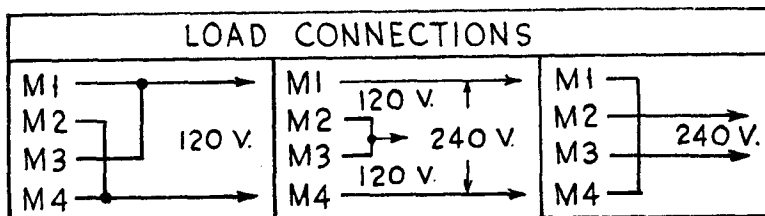

TYPICAL SYMBOL APPLICATIONS

Relay with D.P.D.T. contacts

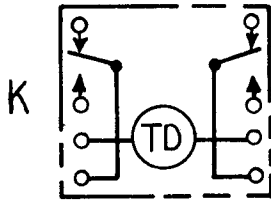

Time delay relay with S.P.D.T. contact

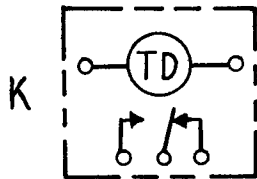

Relay with time delay feature by means of thermal element with S.P.S.T. contact (manual reset)

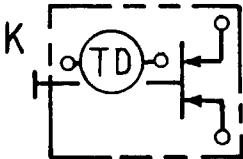

Relay with time delay feature by means of motor with SPDT contacts.

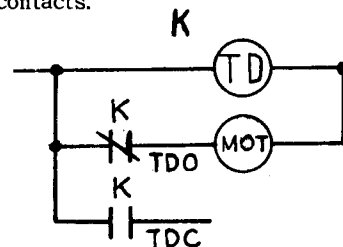
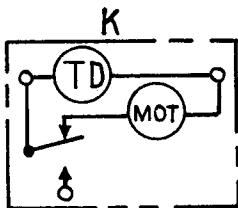

TYPICAL SYMBOL APPLICATIONS

4-position cam operated 13-circuit switch (voltmeter and ammeter selector switch No. 308B22).

**WIRING
DIAGRAM**

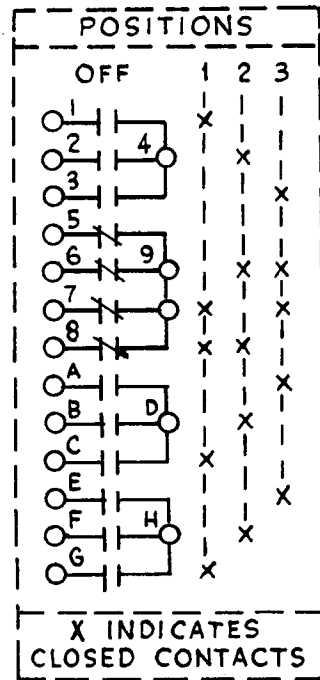
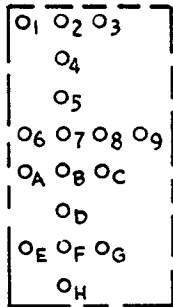

**SCHEMATIC
DIAGRAM**

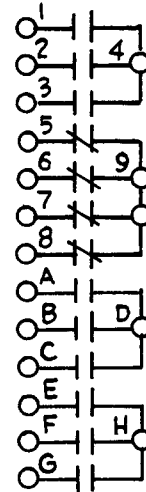

ELECTRICAL SYMBOLS AS SHOWN ON OLD STYLE DRAWINGS

CROSSOVER

Used to designate where two wires cross but are not electrically connected. Any one of the symbols may be used.

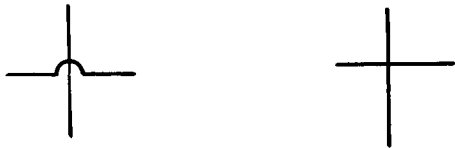

CONNECTED CROSS

Used to designate where two wires cross and are electrically connected. A dot is shown at the point of connection.



TAP

Used to designate where one wire is electrically connected to another wire. A dot is placed at the point of connection.



GROUND

Used to indicate that the circuit is completed through the generator frame or engine. Connections which are not insulated from the frame are called grounded connections. Used also when it is desired to use the earth as a return circuit.



SWITCH

Used to indicate a simple switch.



CIRCUIT BREAKER

Used to designate an automatic safety switch. The amperage at which it opens automatically is usually printed near the symbol.

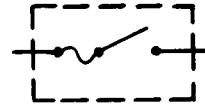

RELAY

Used to designate a relay, where the current of one electrical circuit is used to control one or more other electrical circuits.

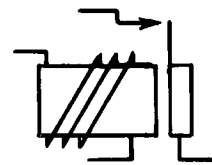

STOP BUTTON

Used to show the stop button of the power plant. Notice that one terminal is grounded.

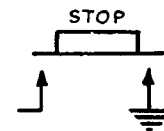

STOP-START BUTTONS

Used to show the start and stop buttons mounted together on the power plant or remote station. One terminal of each button is grounded to a common ground connection.

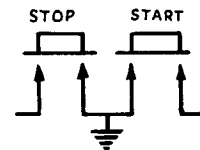

POSITIVE SIGN

Used to designate the positive post of a battery, the positive brush of a generator or the positive side of the circuit in general.



NEGATIVE SIGN

Used to designate the negative post of a battery, the negative brush of a generator or the negative side of the circuit in general.



BATTERY

Used to designate either a storage or dry cell battery.



RHEOSTAT

Used to designate a rheostat. The resistance of a rheostat can readily be varied by means of a knob or lever.

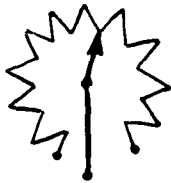

COIL

Used to designate a coil of wire such as the field circuit of a generator or a relay coil.



INDUCTION COIL

Used to designate an induction coil having a primary winding (P) and a secondary winding (S). It usually has a soft iron core. This symbol is used for showing the ignition coil in the magneto and battery ignition systems.

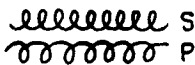

TRANSFORMER

Used to designate a transformer for changing the voltage or current in an alternating current system.

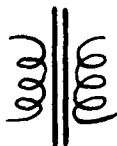

CONDENSER

Two ways used to designate a condenser. The one on the right generally is used.

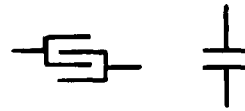

RECTIFIER

Used to designate a rectifier for changing the current in an alternating current system to direct current.

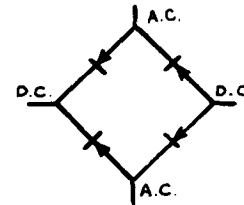

AMMETER

Used to designate the ammeter in a circuit. An ammeter is used to measure the current flow in the circuit.

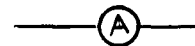

Ammeter with Shunt, used only on DC circuits carrying high amperages. Only a very small portion of the current passes through the meter.

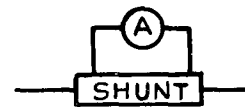

Ammeter with Current Transformer, used only in AC circuits carrying high amperages. Only a small portion of the current flows through the ammeter and secondary circuit.

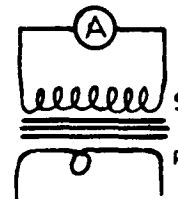

Ammeter in Circuit, series connection. Notice the direct reading ammeter is connected in the circuit to measure

the amperes.

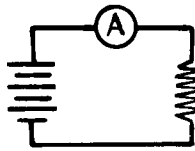

Ammeter in Circuit, with shunt. Notice the shunt is connected in the circuit. The shunt is connected in series with the battery and resistor, and the ammeter is connected parallel with the shunt. Only used in DC circuits.

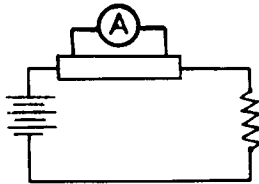

Ammeter in Circuit, with transformer. Notice the primary winding of the current transformer is connected in the circuit. Only a small amount of induced current passes through the secondary winding and the ammeter. Used on AC circuits only.

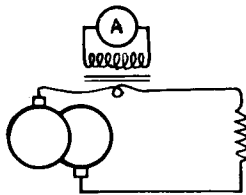

VOLTMETER

Used to designate a voltmeter. A voltmeter measures the pressure in the circuit.



Voltmeter in Circuit, parallel connection. The voltmeter is always connected across the circuit to measure the voltage.

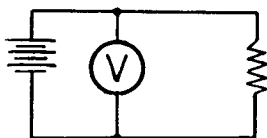

COMMUTATOR AND BRUSHES

Used to designate the commutator and brushes on DC generators and motors.

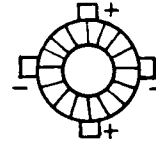

SLIP RINGS OR COLLECTOR RINGS AND BRUSHES

Designates slip rings and brushes on AC generator. Alternating current is collected from them in the revolving armature type generator. Direct current is passed through them into the field coils of the rotating field type generator.

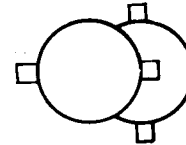

NORTH

Used to designate the north pole of a permanent magnet or electromagnet.

N

SOUTH

Designates the south pole of a permanent magnet or electromagnet.

S

FIELD POLES

Used to designate the field poles of a generator. The poles may be either electromagnets or permanent magnets.

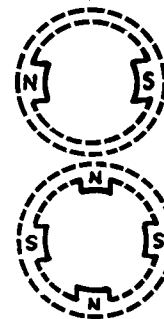

SPARK PLUG

Two ways used to designate spark plugs. The essential feature consists of a break (or gap) in the wire and then a connection to ground.



CONTACT POINTS

Two methods used to designate contact points of distributors, magnetos or relays.



RESISTOR

Designates a resistor. Usually the resistance in ohms will be given near it.



VARIABLE RESISTOR

Designates a resistor arranged so effective resistance can be varied.

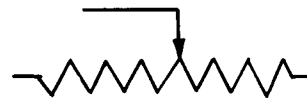

NOMINAL AMPERE RATINGS OF AC GENERATING UNITS

ALWAYS USE KVA RATINGS WHEN SHOWN OR KNOWN			SINGLE PHASE			THREE PHASE						
			POWER FACTOR		120-V AMP	120/240-V AMP	120/208-V AMP	139/240-V 240-V	220/380-V AMP	240/416-V AMP	240/480-V	347/600-V AMP
			80%	UNITY				120/240-V AMP			240/480-V 277/480-V	
KW	KVA	KW=KVA	AMP	AMP	AMP	AMP	AMP	AMP	AMP	AMP		
		0.5	4.2	2.1								
		0.75	6.25	3.2								
		1.0	8.3	4.2								
		1.25	10.4	5.2								
		1.5	12.5	6.2								
		2.0	16.7	8.3								
		2.5	20.8	10.4								
		3.0	25.0	12.5								
		3.5	29.2	14.6		8.3	7.2	4.6	4.2			
		4.0	33.3	17		9.7	8.4	5.3	4.9			
		4.5	38	19		11.0	9.6	6.0	5.6			
4.0	5.0	5.0	42.0	21.0		13	11	7.2	6.3	5.4	4.3	
		6.0	50	25		14	12	8	7.0	6	5	
6.0	7.5	7.5	63	32		16	14	9	8.0	7	6	
		9.0	75	38		21	18	11	10.5	9	7	
		10.0	83	42		25	22	14	12.5	11	9	
10.0	12.5	12.5	104	52		28	24	15	14.0	12	10	
12.5	15.6	15.6	130	65		35	30	19	17.5	15	12	
		15.0	125	63		43	38	23	21.5	19	15	
15.0	18.75	18.75	156	78		42	36	23	21.0	18	14	
		17.5	146	73		53	45	29	26.5	23	18	
17.5	21.87	21.87	182	91		49	42	27	24.5	21	17	
		20.0	167	84		61	53	33	30.5	26	21	
20.0	25.0	25.0	208	104		56	48	30	28.0	24	19	
25.0	31.25		260	130		70	60	38	35.0	30	24	
				125		87	75	48	43.5	38	30	
				156		83	72	46	41.5	36	29	
30.0	37.5			156		104	90	57	52.0	45	36	
35.0	43.75			182		122	105	67	61.0	53	42	
40.0	50.0			208		139	120	76	69.5	60	48	
45.0	56.25			234		156	135	86	78.0	68	54	
50.0	62.5			260		174	151	95	87.0	75	60	
55.0	68.75			286		191	166	105	95.5	83	66	
60.0	75.0			313		209	181	114	104.5	90	72	
65.0	81.25			339		226	196	124	113.0	98	78	
70.0	87.5			365		244	210	133	122.0	105	84	
75.0	93.75			390		261	226	143	130.5	113	90	
80.0	100.0			417		278	240	152	139.0	120	96	
85.0	106.25			443		295	256	162	147.5	128	103	
90.0	112.5			468		312	271	171	156.0	135	108	
100.0	125.0			520		348	300	190	174.0	150	120	
110.0	137.50			573		382	332	210	191.0	166	132	
115.0	143.75			595		400	346	218	200.0	173	138	
125.0	156.25			651		435	376	238	217.5	188	150	
140.0	175.0			729		486	421	266	243.0	211	169	
150.0	187.5					521	452	285	260.5	226	181	
155.0	193.75					538	468	295	269.0	234	187	
165.0	206.25					575	498	314	287.5	248	199	
170.0	212.5					591	513	324	295.5	256	204	
175.0	218.75					609	527	333	304.5	263	211	
190.0	237.5					660	573	361	330.0	286	229	
200.0	250.0					696	602	380	348.0	300	241	
230	287.5					799	693	438	399.5	346	277	
250	312.5					867	751	475	433.5	376	301	
300	375					1042	903	570	521.0	452	361	
350	437.5					1215	1054	666	607.5	527	421	
400	500					1390	1204	761	695.0	602	482	
450	562.5					1560	1354	855	780.0	676	542	
500	625.0					1734	1500	950	867.0	751	600	

NOMINAL AMPERE RATINGS - DC GENERATORS

DIRECT CURRENT CODE AND VOLTAGE				BATTERY CHARGING CODE AND VOLTAGE				
CODE		115	123	150	212	224	232	210
Nominal Volts				14.1-V	28.2-V	37.6-V	129.25-V	
VOLTAGE		115-V	230-V	250-V	12-15-V	24-30-V	32-40-V	110-140-V
KW	AMP	AMP	AMP	AMP	AMP	AMP	AMP	AMP
.4	3.5	1.74	1.6	28.4	14.2	10.6	3	
.5	4.4	2.2	2.0	35.4	17.7	13.3	4	
.6	5.2	2.6	2.4	42.5	21.3	15.95	5	
.75	6.5	3.2	3.0	53.2	26.6	19.9	6	
1.0	8.7	4.3	4.0	71.0	35.5	26.6	8	
1.25	10.9	5.4	5.0	88.6	44.3	33.3	10	
1.5	13.0	6.5	6.0	106.4	53.2	40.0	12	
2.0	17.4	8.7	8.0	142.0	71.0	53.2	16	
2.5	21.8	10.9	10.0	177.3	88.6	66.5	19	
3.0	26.0	13.0	12.0	213.0		80.0	23.0	
3.5	30.4	15.2	14.0	248.0		93.0	27.0	
5.0	43.5	21.8	20.0	355.0		133.0	39	
6.0	52.2	26.1	24.0				47	
10.0	87.0	43.5	40.0				78	
15.0	130.0	65.0	60.0				116.0	

Onan manufactures a complete line of electric power systems from 1 to 500 KW (generator sets • automatic transfer switches • industrial engines), gas-, gasoline- or diesel-driven. For standby power in homes, industrial plants, commercial buildings and institutions. For auxiliary or portable power in boats, recreational vehicles, service trucks and construction equipment.

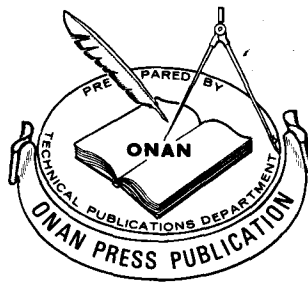

T-012

technical bulletin

INSTALLATION OF ELECTRIC GENERATING SETS FOR RECREATIONAL VEHICLES

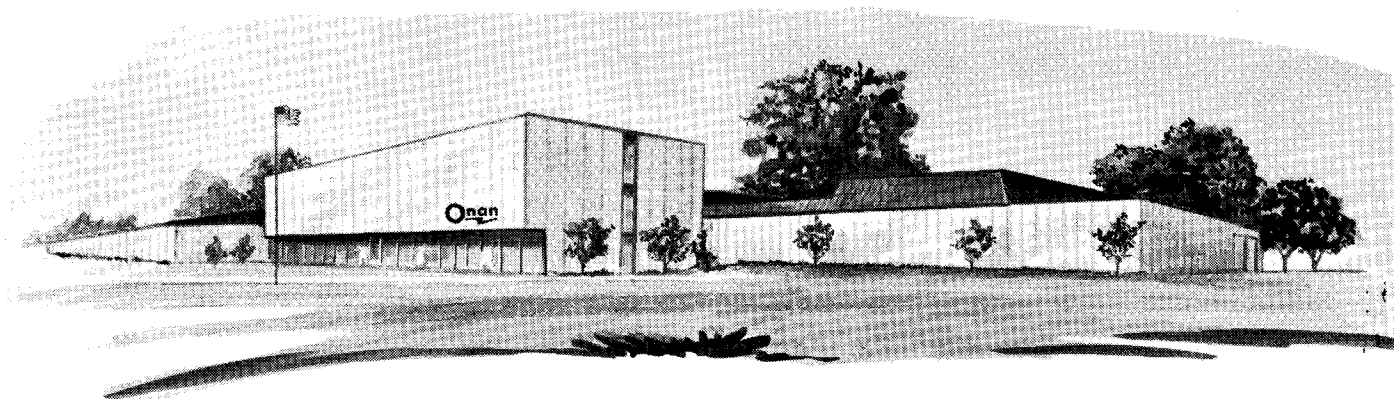

ONAN

1400 73RD AVENUE N.E. • MINNEAPOLIS, MINNESOTA 55432
A DIVISION OF ONAN CORPORATION

Printed in U.S.A.

OCTOBER 1976

SAFETY PRECAUTIONS

The following symbols in this manual signal potentially dangerous conditions to the operator or equipment. Read this manual carefully. Know when these conditions can exist. Then, take necessary steps to protect personnel as well as equipment.

WARNING Onan uses this symbol throughout this manual to warn of possible serious personal injury.

CAUTION This symbol refers to possible equipment damage.

Fuels, electrical equipment, batteries, exhaust gases and moving parts present potential hazards that could result in serious, personal injury. Take care in following these recommended procedures.

- **Use Extreme Caution Near Gasoline. A constant potential explosive or fire hazard exists.**

Do not fill fuel tank near unit with engine running. Do not smoke or use open flame near the unit or the fuel tank.

Be sure all fuel supplies have a positive shutoff valve.

Fuel lines must be of steel piping, adequately secured and free of leaks. Use a flexible section of fuel line between generator set and stationary fuel line in the vehicle. This flexible section must be 100% NON-METALLIC to prevent electrical current from using it as a conductor.

Have a fire extinguisher nearby. Be sure extinguisher is properly maintained and be familiar with its proper use. Extinguishers rated ABC by the NFPA are appropriate for all applications. Consult the local fire department for the correct type of extinguisher for various applications.

- **Guard Against Electric Shock**

Remove electric power before removing protective shields or touching electrical equipment. Use rubber insulative mats placed on dry wood platforms over floors that are metal or concrete when around electrical equipment. Do not wear damp clothing (particularly wet shoes) or allow skin surfaces to be damp when handling electrical equipment.

Jewelry is a good conductor of electricity and should be removed when working on electrical equipment.

Always use an appropriately sized, approved double-throw transfer switch with any standby generator set. **DO NOT PLUG PORTABLE OR STANDBY SETS DIRECTLY INTO A HOUSE RECEPTACLE TO PROVIDE EMERGENCY POWER.** It is possible for current to flow from generator into the utility line. This creates extreme hazards to anyone working on lines to restore power.

Use extreme caution when working on electrical components. High voltages cause injury or death.

Follow all state and local electrical codes. Have all electrical installations performed by a qualified licensed electrician.

- **Do Not Smoke While Servicing Batteries**

Lead acid batteries emit a highly explosive hydrogen gas that can be ignited by electrical arcing or by smoking.

- **Exhaust Gases Are Toxic**

Provide an adequate exhaust system to properly expel discharged gases. Check exhaust system regularly for leaks. Ensure that exhaust manifolds are secure and not warped.

Be sure the unit is well ventilated.

- **Keep The Unit And Surrounding Area Clean**

Remove all oil deposits. Remove all unnecessary grease and oil from the unit. Accumulated grease and oil can cause overheating and subsequent engine damage and may present a potential fire hazard.

Do NOT store anything in the generator compartment such as oil cans, oily rags, chains, wooden blocks etc. A fire could result or the generator set operation may be adversely affected. Keep the floor clean and dry.

- **Protect Against Moving Parts**

Avoid moving parts of the unit. Loose jackets, shirts or sleeves should not be permitted because of the danger of becoming caught in moving parts.

Make sure all nuts and bolts are secure. Keep power shields and guards in position.

If adjustments *must* be made while the unit is running, use extreme caution around hot manifolds, moving parts, etc.

Do not work on this equipment when mentally or physically fatigued.

Table of Contents

GENERAL	2
Model Selection	2
Considering Load Applications	2
Air Conditioning Loads	2
LOCATION	4
Compartment Location	4
Compartment	5
Mounting	5
Vibration Isolators	5
VENTILATION AND ACOUSTICS	7
Vacu-Flo Cooling	7
Air Requirements	7
Suggestions for Quieter Operation	7
FUEL SYSTEM	10
Fuel Consumption	10
Fuel Lines and Fuel Filters	10
Fuel Solenoid	11
Gasoline Evaporative Control Systems	11
EXHAUST SYSTEM	13
Exhaust Spark Arresters	13
ELECTRICAL LOADS AND CONNECTIONS	14
Wire Types	14
Disconnect Switch	14
Recommended Transfer Mechanisms	14
Load Connections	14
Starting Controls	16
Final Check-Out Procedure	16
BATTERIES	18
Battery Care	18
Batteries and Battery Cables	18
Battery Cables	18
Battery Selection	18
Battery Size	18
REMOTE ACCESSORIES	19
PRE-START CHECKS	21

WARNING

*TO PREVENT FIRE OR ACCIDENT HAZARD . . .
THIS UNIT MUST BE INSTALLED ACCORDING
TO THE MANUFACTURER'S DETAILED IN-
STALLATION PROCEDURES OBSERVING ALL
MINIMUM CLEARANCES.*

*TO AVOID POSSIBLE PERSONAL INJURY OR
EQUIPMENT DAMAGE, ANY INSTALLATION
AND ALL SERVICE MUST BE PERFORMED BY
QUALIFIED PERSONNEL.*

General

The requirements and recommendations throughout the bulletin are based on the:

1. National Electrical Code (NEC).
2. Recreational Vehicle Institute, Inc. (ANSI A119.2).
3. National Fire Protection Association (NFPA 501C).
4. Recommendations of Onan engineers, distributors, dealers and servicemen.
5. CSA Requirements (Bulletin #946).

All requirements and recommendations are used in conjunction with manufacturers of motor homes, display vehicles, trailers and associated RV equipment. State and local codes must also be followed.

Due to various recreational vehicle chassis types and different installations, information given is quite general and must be adapted for particular installations. Refer to the appropriate operator's manual and/or installation guide for specific information.

MODEL SELECTION

Size, weight, electrical characteristics, etc., are important when determining the correct Onan generator set for a given recreational vehicle application. However, read the entire bulletin covering cooling, fuel and wiring before making a final choice if the unit is expected to:

1. Deliver rated output when installed in compartment.
2. Start dependably.
3. Operate safely.
4. Be serviceable.

CONSIDERING LOAD APPLICATIONS

When determining the size of the generator set thought to be needed for a given electrical load, consider the following points:

1. Total appliance loads to be used . . . refrigerator, water heater, water pump, etc. Note starting loads since they place higher demands than running loads. See Table 2.
Consider air conditioning loads separately since they are often the largest load in the recreational vehicle (see *Air Conditioning Loads*).
2. Loads which operate simultaneously.
3. Extra loads which might be added in the future.

AIR CONDITIONING LOADS

Probably the largest single load encountered for the electric generating set in a recreational vehicle installation is an air conditioner. Generator set sizing, more often than not, is dependent on the nature and characteristics of the air conditioner. Most air conditioners used are designed to operate from a commercial power source and can present problems to electric generating set. For this reason, care must be taken in selecting the set for air conditioning loads.

Current draw from any air conditioner is high while starting and becomes less as the air conditioner's motor reaches synchronizing speed. The instant the air conditioner's compressor starts pumping refrigerant, the load on the motor and current draw increases again. After the inside temperature of the recreational vehicle lowers, motor load and motor current draw declines. The air conditioner operates

TABLE 1. ELECTRIC GENERATING SETS

MODEL	ELECTRICAL CHARACTERISTICS					WEIGHT (LB)
	WATTS	VOLTS	AMP	PHASE	WIRE	
2.5LK-3CR	2,500	120/240	20.8-10.4	1	4*	225
2.7AJ-1R	2,750	120	22.9	1	2	147
4.0CCK-3CR	4,000	120/240	33.4-16.7	1	4*	290
4.0BF-3CR	4,000	120/240	33.4-16.7	1	4*	217
4.0BF-1R	4,000	120	33.4	1	2	300
5.0CCK-3CR	5,000	120/240	41.6-20.8	1	4*	315
6.0NH-1R	6,000	120	50.0	1	2	382
6.5NH-3CR	6,500	120/240	54.2-27.1	1	4*	327

* - Can be two-wire connected for rated output at 120 volts or three-wire connected for 120/240 volts. Higher ampere rating shown is for 120 volts.

**TABLE 2.
POWER REQUIREMENTS FOR APPLIANCES**

Appliance or Tool	Approximate Running Wattage
Refrigerator	600-1000
Electric broom	200-500
Coffee percolator.....	550-700
Electric frying pan	1000-1350
Hair dryer	350-500
Electric stove (per element)	350-1000
Electric iron	500-1200
Radio	50-200
Electric water heater.....	1000-1500
Space heater	1000-1500
Electric blanket.....	50-200
Television	200-600
Electric drill	250-750
Battery charger.....	Up to 800
Electric water pump	500-600
Air Conditioner.....	1400-2200
Converter	300-350
Microwave Oven.....	700-1500

for some time and probably stops. Restarting the air conditioner, probably the largest single starting test for the generator set, is more difficult because the internal temperature of the air conditioner has become much higher. With these points in mind, use the set selection procedure following.

1. Determine the running watts of each air conditioner from the nameplate. For operation in 100° F ambients, add 300 watts to the running watts. See Table 3.
2. Select the electric generating set from Table 4. It gives the available accessory load in watts of each set while starting various air conditioners in ambients up through 100° F.

Available accessory load will vary from installation to installation. Factors affecting this amount are altitude, carbon and lead buildup in engine, ambient temperature, compartment cooling system design, type of air conditioner and its starting time. Some can be compensated for by derating to assure the set and air conditioner operate properly. See steps 3 and 4.

3. Derate the generator set 4.5 percent for each 1000 feet above 1000-foot altitude (9 percent at 3000-foot altitude, for example).
4. Carbon and lead deposits in the set engine require a 10 percent derating if not removed after each 500 hours of operation.

**TABLE 3.
TYPICAL AIR CONDITIONER LOADS**

BTU AIR CONDITIONER	ONE AIR CONDITIONER'S LOAD (WATTS)
11,000	1800
12,000	2000
13,500	2200

TABLE 4. ELECTRIC GENERATING SET STARTING CAPACITIES (100° F Ambient) AND AVAILABLE ACCESSORY LOADS*

Series	Available Accessory Load (Watts) While Starting One Air Conditioner			Available Accessory Load (Watts) While Starting Two Air Conditioners**		
	11,000 BTU	12,000 BTU	13,500 BTU	11,000 BTU	12,000 BTU	13,500 BTU
2.5LK	1300	1000	800	Not Recommended		
2.7AJ	1500	1200	1000			
4.0BF-3CR	2500	2300	2000			
4.0BF-1R Power Drawer	2500	2300	2000	Not Recommended		
4.0CCK-3CR	2500	2300	2000			
5.0CCK-3CR	3800	3500	3300			
6.0NH-1R Power Drawer	4600	4400	4100	3200	2600	2200
6.5NH-3CR	5000	4800	4400	3800	2800	2500

* - Available accessory loads based on typical values for recreational vehicle air conditioners from Table 3 and set capacities.

Add 500 watts to available accessory load after vehicle interior cools to 80° F.

** - Simultaneous starting.

Location

COMPARTMENT LOCATION

Compartment location is determined largely by:

1. Physical size.
2. Access opening.
3. Mounting support . . . most important of all.

Physical Size

The area in the vehicle for the electric generating set must be large enough for the compartment with minimum clearance between the generator set and compartment walls or ceiling (and acoustical material, if used) as specified by Onan in each individual installation guide.

Access Opening

Plan the location for an access opening large enough to permit set removal. Compartment door should be

designed for easy removal, or so door can be propped up for operator's or serviceman's ease.

Mounting Support

Because of compartment weight, the most desirable mounting location is between the main frame members of the recreational vehicle. However, this is seldom possible. Most common installations are on the side of the vehicle and most difficult to reinforce. One side of the compartment is fastened to the frame and the opposite side secured to the body (Figure 1). Channel, box or angle iron can be used for a compartment frame with a sheet metal cover.

The compartment can be supported from above when the unit is below the level of the recreational vehicle main frame members. However, compartment structural design must be rugged enough to withstand severe forces in all directions.

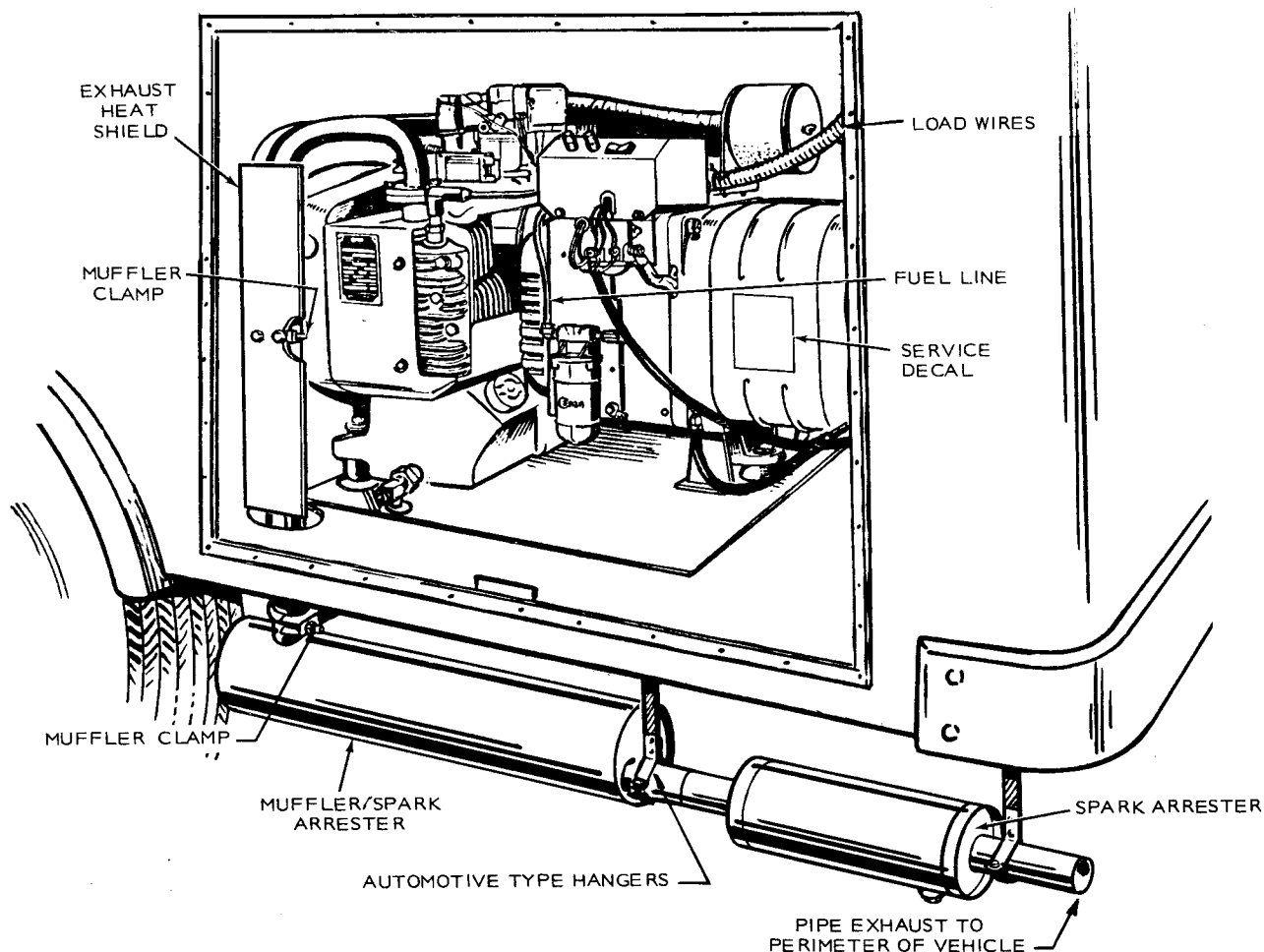

FIGURE 1. TYPICAL ELECTRIC SET INSTALLATION

COMPARTMENT

1. Compartment or installation area must be separated from living quarters by a vapor-tight wall.
2. Line the compartment or separate generator set from living quarters with a fire barrier of sheet metal or other noncombustible material. The compartment can also be readily sealed and lends itself easily to sound or acoustical treatment.

WARNING Do not use flammable material directly above or around the generator set compartment. Heat transferred through the sheet metal compartment structure or other material can be high enough to discolor, char or ignite fiberboard, seat cushions, etc. Use of asbestos or other noncombustible temperature insulating material in high temperature areas may be necessary.

3. Clearance between compartment walls or ceiling (and acoustical material, if used) and set should be adequate to prevent the temperature of combustible material from exceeding 117° F (65° C) rise. For models with generator cooling inlets on the generator end, make sure adequate clearance (one inch minimum) is left for entrance of cooling air. Refer to individual installation guides for UL listed models.
4. Compartment bottom must have minimal openings to reduce entrance of road dirt.
 - A sheet metal base plate is desirable. However, plywood of sufficient thickness for strength can be used if covered with sheet metal for protection.
 - Equip base with a drain hole to outside of compartment.

WARNING Be sure hole is not directly above muffler to prevent fire hazard.

- Do not use absorbent material on inside of compartment floor.
5. Locate the battery outside generator set compartment. See the section on *Batteries*.

MOUNTING

Before actual mounting of the generator set takes place, read the entire bulletin. Also, consider the following mounting points:

1. Air cleaner should be easy to remove.
2. Battery or batteries must be accessible.
3. Oil fill, drain and oil dipstick should be easy to reach and service.

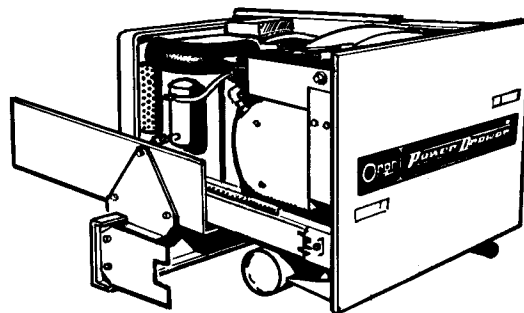

FIGURE 2. TYPICAL "POWER DRAWER" MODEL

4. Sufficient clearance must be left around exhaust system See *EXHAUST* section.

Though not usually the case due to installation restrictions, Onan RV sets of 6500 watts and less can have a compartment with the unit on a pull-out tray for service and repair. Load wires, control wires and fuel lines must have sufficient slack and flexibility so unit can slide out without disconnecting them. The 4.0BF and 6.0NH Power Drawer models are self-contained generator sets mounted on a pull-out drawer as standard. Their fuel and electrical connections are on the outside of the compartment. See Figure 2.

If the unit has a mounting plate, bolt the unit and plate securely in place. If the unit does not have a plate, see *Vibration Isolators*.

VIBRATION ISOLATORS

Rubber vibration isolators are furnished with all Onan recreational vehicle models.

CAUTION Use only the vibration isolators provided with the electric generating set, as they are designed to support unit's weight.

1. Onan mounts are a "fail safe" type which prevent the unit from breaking loose if they are damaged.
2. Vibration isolators of the type shown on the lower right (with snubbing washers) in Figure 3 must be installed properly to minimize vibration. Leave 1/16-inch minimum clearance between the snubbing washers as shown.

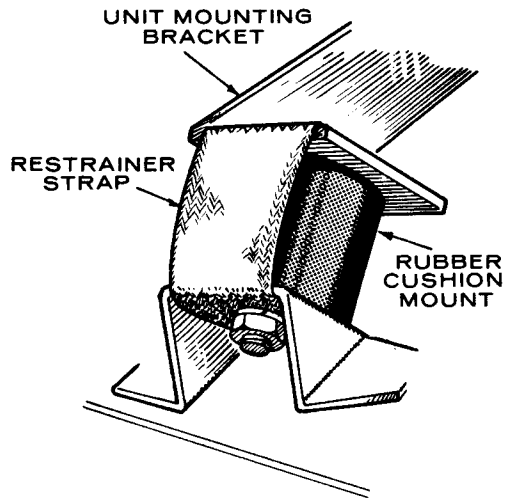
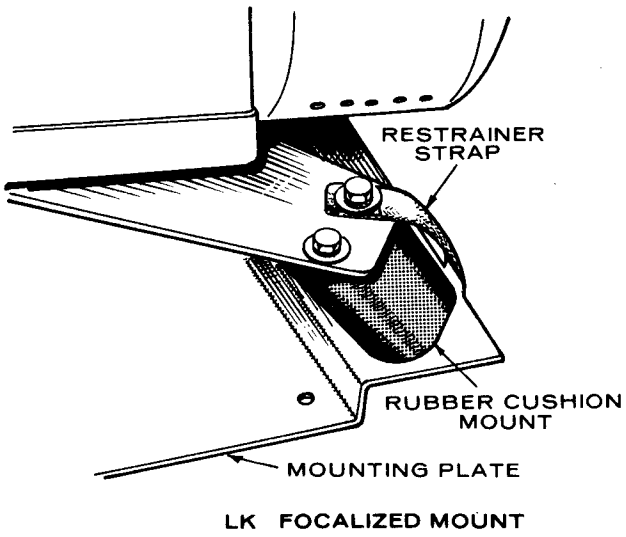

B99

AJ FOCALIZED MOUNT

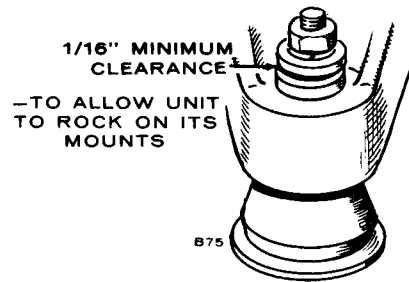

RUBBER CONE MOUNT FOR CCK, CCKB, NH AND BF

FIGURE 3. VIBRATION ISOLATORS

Ventilation and Acoustics

The most important factors of ventilation for an air-cooled RV electric generating set are sufficient incoming cooling air and exhausting heated air. Before considering the installation problems, knowledge of how an Onan unit cools itself is needed.

VACU-FLO COOLING

All Onan electric generating sets for recreational vehicles use Vacu-Flo cooling, a centrifugal fan in a scroll housing on the engine end (Figure 4).

1. It draws air from the generator end of the compartment, through the generator and over the cooling surfaces of the engine, then discharges the heated air out through the Vacu-Flo discharge opening.
2. All standard sets for recreational vehicles have the Vacu-Flo scroll positioned downward. Be sure nothing obstructs or restricts discharged airflow.

WARNING

Never use discharged cooling air for heating since it can contain poisonous gases.

Allow for ducts or obstructions of airflow. Position of the air openings must permit airflow while the unit is running to purge the compartment of heated air. But on shutdown, the openings must allow for convection cooling of the compartment for heated air to escape.

AIR REQUIREMENTS

Cooling air requirements for Onan electric generating sets vary with type and size. While figures

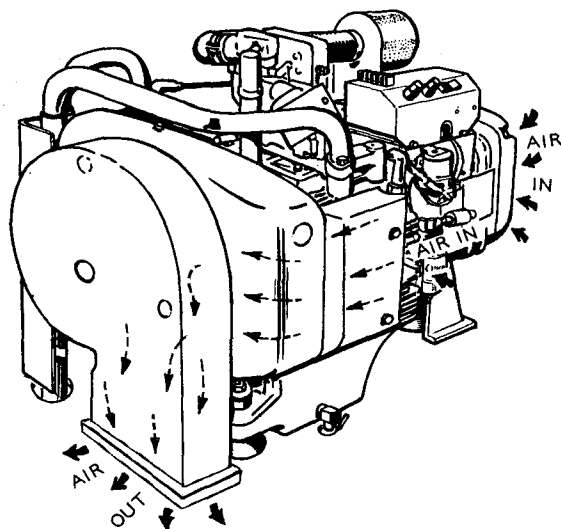

FIGURE 4. TYPICAL ONAN RV COOLING SYSTEM

TABLE 5. RV ELECTRIC SET AIR REQUIREMENTS*

RV SERIES	RPM	AIR DISCHARGE (CU.FT./MIN.)	MIN. FREE AIR INLET, NO RESTRICTION (SQ. IN.)	MIN. AIR OUTLET SIZE (SCROLL OPENING)
2.5LK	1800	450	100	(3 x 8)
2.7AJ	3600	325	75	(4½ x 7)
4.0CCK	1800	550	100	(3 x 8)
4.0BF	1800	480	85	(9½ x 3½)
5.0CCK	1800	550	100	(3 x 8)
6.5NH	1800	650	120	(4 x 8)

* - BF and NH "Power Drawer" models have fixed air inlet and outlet.

NOTE: Allow for airflow restrictions due to elbows in a duct, etc.

for air discharge are given in Table 5, special equipment is needed to measure it. Since the discharge area can't be changed, air inlet opening is critical. Table 5 also gives the total free inlet area recommended.

Restricted Air Openings

Expanded metal, screen or sheet metal with louvers or slots can be used over inlet areas. However, some provide only 60 percent free inlet area per square foot. Even the most efficient grille only provides about 90 percent free inlet area per square foot. The free inlet area of the material can be obtained from the manufacturer. Calculate the inlet area needed using the following example as a guide.

Example: Unrestricted air inlet requirements for a generator set is 140 square inches. The compartment door louvers provide 85 percent free inlet area per square foot. Divide 140 square inches by 0.85 (85 percent) to determine necessary inlet area.

$$\frac{140 \text{ sq. in.}}{0.85} = 165 \text{ sq. in.}$$

Air Inlet Location

If possible, always locate the air inlet on the side of the vehicle and as high as possible to minimize entrance of dirt and dust. With a rear air inlet, the generator set often has difficulty moving sufficient cooling air through the compartment, due to the vacuum created behind the vehicle during transit.

SUGGESTIONS FOR QUIETER OPERATION

Two general types of noise encountered with a generator set for recreational vehicles are airborne and structural vibration noise. Most structural vibration noises can be reduced by vibration isolators, skin dampers in the form of lead-filled plastic or other

high-density attachable materials, flexible fuel and electrical connections, etc. Compartment acoustical lining and special compartment design can usually reduce airborne noises.

Compartment Acoustical Lining

1. Be sure all joints and corners of the compartment are vapor tight to coach interior before lining with acoustical material.

Lining the compartment does little if opening, cracks, door and joints are not sealed. Also make sure compartment door edge is sealed to eliminate noise-air leaks around the door perimeter.

2. Cover the sound reflective surfaces, back, top and sides (not compartment base) with fiberglass or other noncombustible acoustical material. It should be no less than one-inch thick and approximately four pounds per square foot in density. Be sure adhesive used is also noncombustible. Test acoustical material and adhesive for heat effects before using.
3. Rather than using fiberglass or like material of four pounds per square foot density, a combination of materials can reduce noise even more. For example, a sheet of lead or viscoelastic material of one-half to one pound per square foot density and a layer of one-inch acoustical material of four pounds per square foot density, respectively, is far more superior.
4. To prevent line of sight noise indication, a sound panel (baffle) may be added behind lowered air inlet. The panel must be spaced to allow for minimum free air inlet of 100 square inches. See Figure 5.

WARNING

Separate installation area or compartment from living quarters by a vapor-tight wall to prevent entrance of noxious fumes to interior.

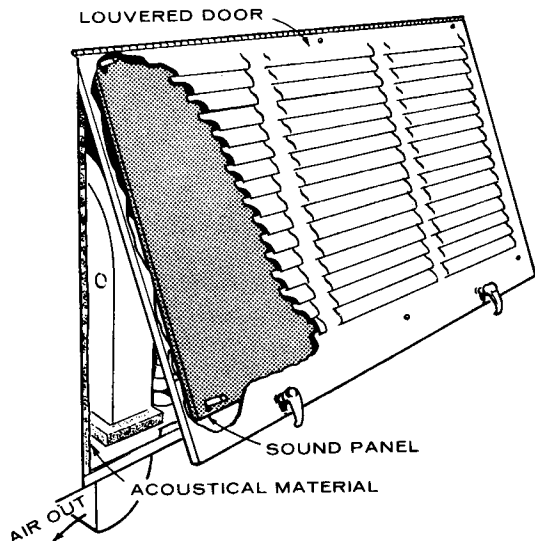

FIGURE 5. BAFFLE CONCEPT COMPARTMENT

Compartment Design

Compartments can be designed to prevent line-of-sight noise radiation. Four types of compartment designs are discussed:

1. Baffle concept.
2. Shelf concept.
3. Panel concept.
4. Z-duct concept.

The baffle concept is accomplished by mounting a panel on the inside of a louvered service door (Figure 5). The panel must be spaced to allow for free inlet airflow, yet not allow line-of-sight to the generator set. Often this compartment does not lend itself to effective noise reduction because the louvers in the door extend beyond the panel's edges.

Shelf-concept compartments are effective because they allow more acoustical material to be used on the air inlet. The incoming air goes past the unit and must make one 90-degree turn before entering the compartment proper (Figure 6). Available space above or beside the generator set determines the depth of the shelf. Depth of the shelf must not restrict airflow.

However, due to space limitations, the shelf-concept is seldom possible. For such instances the panel concept can be used (Figure 7). It requires very little room and prevents line-of-sight to the noise source.

One of the most effective compartment designs is the Z-duct concept. Incoming air must make at least one 90-degree turn (usually two) before it enters the compartment. See Figure 8. Depth of the duct must be determined to allow for inlet air and still allow for clearance between the generator set and the back

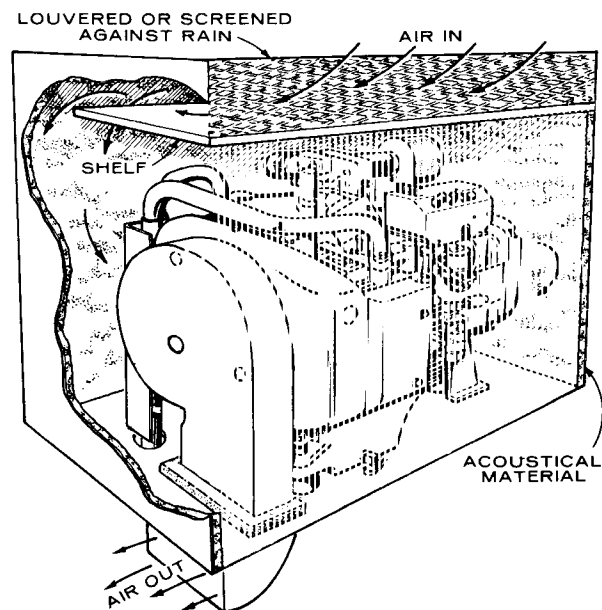

FIGURE 6. SHELF-CONCEPT COMPARTMENT

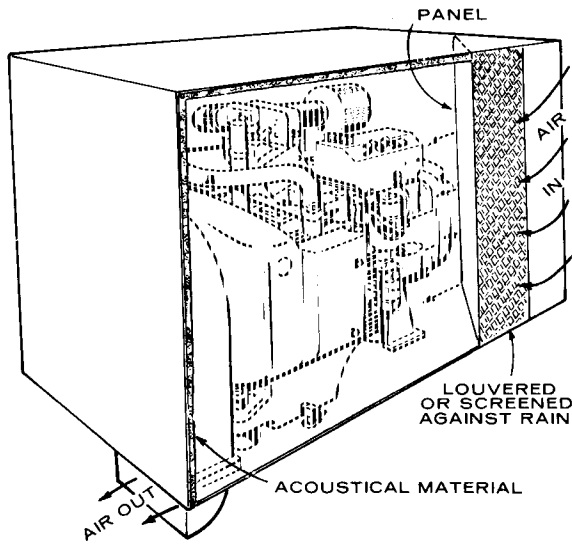

FIGURE 7. PANEL-CONCEPT COMPARTMENT

side of the duct and acoustical material, where applicable. Acoustical material lining inside the duct, if used, must not restrict airflow.

Air Outlet Duct

Noise of discharged air from the compartment can be

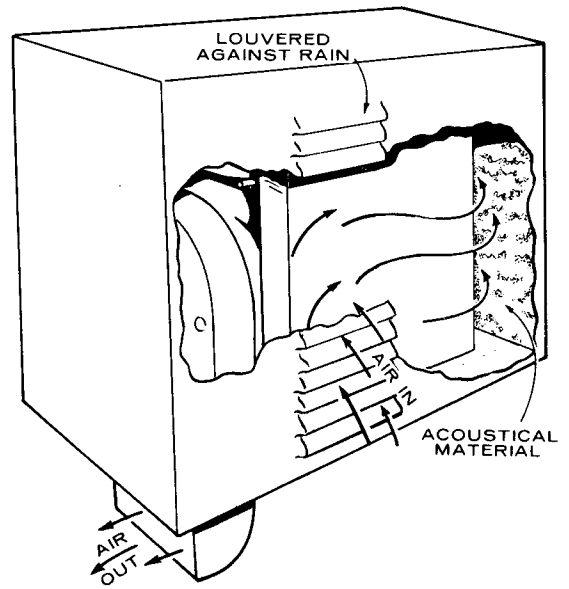

FIGURE 8. Z-DUCT CONCEPT COMPARTMENT

reduced by adding a duct (Figures 5 through 8) to direct the airflow under the vehicle. For most effective acoustical treatment, line the duct with acoustical material which is resistant to oil or gas absorption, and is fire resistant. Ducting or acoustical treatment material must not restrict discharge airflow from the set.

Fuel System

All Onan AC electric generating sets for recreational vehicles use gasoline fuel. Because any AC generator set runs at a constant speed, lead deposits tend to build up in the combustion chambers. For this reason, use clean, fresh, no lead or low-lead gasoline. Regular grade gasoline may also be used, but DO NOT use highly leaded premium types of fuel.

For new engines, the most satisfactory results are obtained by using unleaded gasoline. For older engines that have previously used leaded gasoline, the cylinder heads must be taken off and all lead deposits removed from engine before switching to unleaded gasoline.

CAUTION Lead deposits must be removed from an engine before switching from leaded to unleaded gasoline. If not, preignition can occur causing engine damage.

Most Onan recreational vehicle gasoline generator sets have electric fuel pumps as standard. The other recreational vehicle models have mechanical fuel pumps. Choice of fuel pump type used is primarily for prevention of vapor lock.

WARNING Leakage of gasoline in or around the compartment is a definite hazard. The ventilation system should provide a constant flow of air to expel any accumulation of fuel vapor while the vehicle is in transit. Compartments must be vapor tight to the interior to keep fumes from within the vehicle.

Gaseous Fuel

This fuel does have some advantages over gasoline, but Onan does not use (on AC RV models) and does not recommend gaseous fuel operation for the following reasons:

1. Complex installation—requires special lines, solenoid valve, strainer, regulators, gauges, etc.
2. High installation costs.
3. Usually limited bulk fuel availability.
4. Set capacity limited by physical size of tanks.
5. Lower engine power.
6. Poor and erratic low temperature starting and operation.

FUEL CONSUMPTION

It should be noted that under varying electrical loads, engines for recreational vehicle generator sets can use up to the fuel consumption figures shown in Table 6 for rated output.

TABLE 6. FUEL CONSUMPTION

MOBILE UNIT	GALLONS/HOUR (at rated load)
2.5LK	0.52
2.7AJ	0.54
4.0CCK	0.88
4.0BF-3CR	0.88
4.0BF-1R	0.88
5.0CCK	1.05
6.0NH	1.05
6.5NH	1.30

If the vehicle fuel tank is shared, design the fuel tank withdrawal system to insure the set cannot use the entire supply. See *Sharing Fuel Tank Supply* following.

SHARING FUEL TANK SUPPLY

Most electric generating set installations are designed to share the vehicle fuel supply tank with the vehicle engine. All connections to vehicle fuel system must be in accordance with chassis (vehicle) manufacturers' detailed installation instructions.

FUEL LINES AND FUEL FILTERS

Fuel Lines

1. Use seamless steel tubing and flared connections.
2. Run fuel lines at the top level of tank to a point as close to the engine as possible to reduce danger of fuel siphoning out of tank if the line should break.
3. Keep fuel lines away from hot engine or exhaust areas. This reduces chance of vapor lock.
4. Line must be long enough to prevent binding or stretching because of set movement.
5. Install an approved flexible nonmetallic and non-organic fuel line between the solid fuel line and engine to absorb vibration.
6. Install lines so they are accessible and protected from damage.
7. Use nonferrous metal straps without sharp edges to secure the fuel lines.

Fuel Filters

Onan electric generating sets with electric fuel pumps have phenolic or screen filters within the fuel pump itself. Additional filters in the fuel line are unnecessary unless unusual operating conditions exist.

Operating the generator set from a tee in the main fuel line can cause erratic operation. The set's fuel pump has neither the capacity nor the power to overcome the draw of vehicle engine fuel pump.

FUEL SOLENOID

The positive fuel shutoff valve prevents flooding of the generator set, when not in use, should the vehicle fuel tank become pressurized.

GASOLINE EVAPORATIVE CONTROL SYSTEMS

With the increasing emphasis on pollution controls, certain states are now requiring strict evaporative controls on vehicle gasoline supply systems. Manufacturers of RV chassis and vehicles in general have complied to new regulations for these areas by using special design gas tanks, filler tubes, filler gas caps and interconnecting vapor tubing from the vehicle gas tank through a special canister to the vehicle engine.

Because these systems are designed to operate in a critical pressure range, it is very important during connection of an electric generating set and building of the motor home, etc., the vehicle manufacturer's fuel supply design not be altered. The filler tube, fill limiter vent, canister, vapor lines and gas fill cap should not be changed, removed or replaced unless receiving recommendations and approval from the vehicle manufacturer. If not, serious vehicle engine and generator set operating conditions could result. Always check the filler gas cap to make sure it has a pressure and vacuum relief valve. Also check to make sure it works.

Because various designs of such systems exist, Figure 9 shows a typical gasoline evaporative control system. By checking the vehicle chassis for a canister, vapor lines, etc., you should be able to identify whether or not it has an evaporative control system.

If operating problems develop due to the fuel system, check the fill cap to make sure the vacuum and pressure relief valve is working properly.

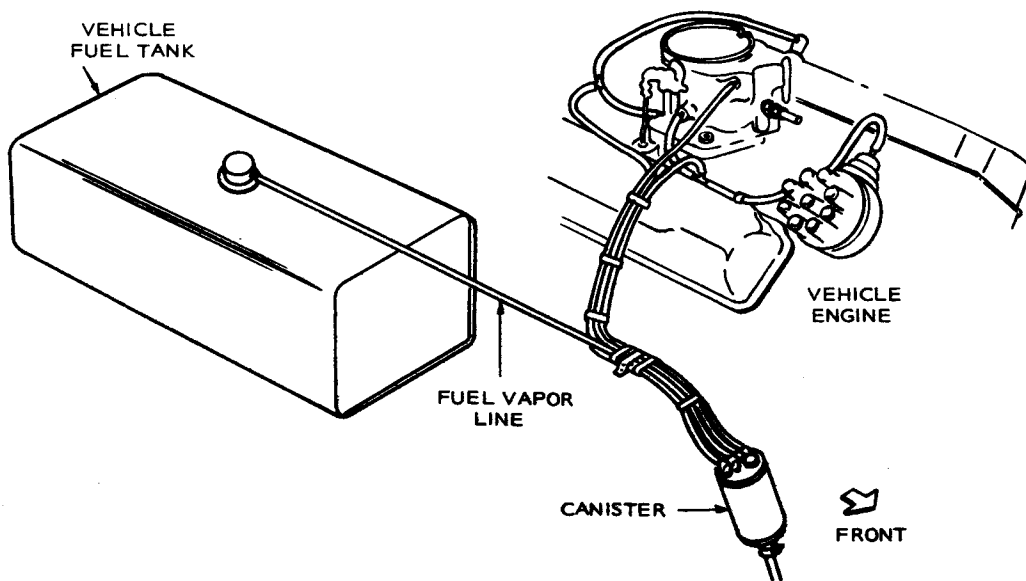

FIGURE 9. TYPICAL EVAPORATIVE CONTROL SYSTEM

WARNING

ENGINE EXHAUST GAS (CARBON MONOXIDE) IS DEADLY!

Carbon monoxide is an odorless, colorless gas formed by incomplete combustion of hydrocarbon fuels. Carbon monoxide is a dangerous gas that can cause unconsciousness and is potentially lethal. Some of the symptoms or signs of carbon monoxide inhalation are:

- Dizziness
- Intense Headache
- Weakness and Sleepiness
- Vomiting
- Muscular Twitching
- Throbbing in Temples

If you experience any of the above symptoms, get out into fresh air immediately.

The best protection against carbon monoxide inhalation is a regular inspection of the complete exhaust system. If you notice a change in the sound or appearance of exhaust system, shut the unit down immediately and have it inspected and repaired at once by a competent mechanic.

Exhaust System

Plan each individual exhaust system carefully. A good installation not only is gas tight, but usually quieter, too. Be sure to check all applicable recreational vehicle standards, local codes and regulations.

WARNING

Plan the exhaust system carefully. Exhaust gases are deadly!

CAUTION

Do not connect the generator set exhaust to the vehicle exhaust system. Water vapor from one engine can damage the other engine.

1. Where the exhaust system passes through the base or floor, leave adequate clearance as protection against exhaust pipe damage from vibration (Figure 10).
2. The exhaust system must be no closer than six inches from any combustible material; or, be so located, insulated or shielded so it does not raise the temperature of any combustible material by more than 117 F degrees above the ambient air inlet temperature after the generator set has run at full load for one hour.
3. The exhaust system must terminate aft of the generator set compartment and extend to the perimeter of vehicle.

WARNING

Do not terminate exhaust under vehicle, as carbon monoxide gas is poisonous. Direct exhaust gases away from window and door openings.

4. Exhaust pipe must terminate a minimum of three feet from the vehicle gasoline filler spout (more distance if required by local codes).
5. Use the largest possible radius elbows on the exhaust lines and as few elbows as possible. If not, the system might create high back pressure.
6. Use automotive type tail pipe hangers for hanging the exhaust system from vehicle undercarriage.

CAUTION

If tail pipe deflector is used, be sure it is large enough to prevent excessive back pressure.

EXHAUST SPARK ARRESTERS

Exhaust spark arresters are necessary when operating in some parks and camps. Two basic types are used in the recreation vehicle industry. One is a

IMPORTANT: Certain states (particularly California) have state ordinances pertaining to the type and usage of exhaust muffler/spark arresters on internal combustion engines or engine driven equipment when used in a recreational vehicle such as electric generating sets. Be sure your installation meets all Federal, State and local codes pertaining to your unit. Failure to provide and maintain a spark arrester may be in violation of the law.

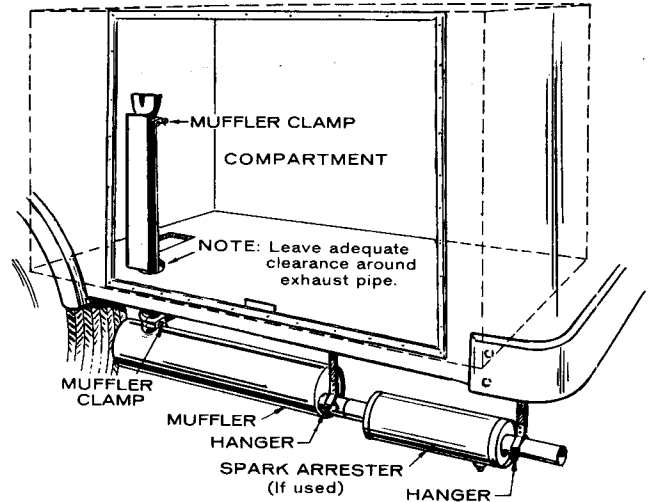

FIGURE 10. TYPICAL EXHAUST SYSTEM INSTALLATION

spin-out type spark arrester, the other is a screen type spark arrester. All require periodic clean-out (every 50 to 100 operating hours) to maintain maximum efficiency.

Spin-Out Type Spark Arrester

This type removes carbon particles by centrifugal force, catching the particles in a holding chamber. Removing a pipe plug from the arrester and operating the generator set (at a convenient time and place) cleans out the deposits. It is important to note this arrester does not plug up when the holding chamber is full and does not cause harmful, high exhaust back pressure. When full, particles pass through the arrester.

Screen Type Spark Arrester

This arrester has a screen which traps carbon particles as they pass through. The screen is removed, cleaned or replaced after it has filled. A disadvantage of this type is the screen plugs as it collects the particles and gradually increases exhaust back pressure. Back pressure causes a loss of engine power and can cause burned or damaged valves if pressure is high enough. It is very important this type be cleaned as recommended.

WARNING

On all listed models with exhaust shielding supplied with unit, shielding **MUST** be properly installed to prevent overheating of compartment walls or the possibility of fire. Refer to appropriate installation guide for each model for details.

Electrical Loads and Connections

All of the following description pertains to alternating current Onan electric generating sets for recreational vehicles.

1. All wiring must meet applicable local electrical codes. Have a qualified electrician install and inspect the wiring.
2. Wires must be adequate size, properly insulated and supported in an approved manner.
3. Mount switches and controls securely to prevent damage from vibration and road shocks. All switches must be vibration-proof to prevent accidental opening or closing while the vehicle is in motion.
4. Install an approved junction box for feeder conductors from the electric generating set. It must have a blank cover and be inside compartment (not on set).

WARNING

To prevent noxious gases from entering vehicle interior, seal any openings made in the set's compartment for conduit, wiring, etc.

WIRE TYPES

Use multistrand wire which meets all applicable codes as feeder conductors, from electric generating set to compartment junction box. Many installers use multistrand wire throughout the vehicle to reduce the danger of breakage from vibration.

The generator set conductors must be able to carry at least 115 percent of the generator nameplate current (amperes). Neutral conductors must be the same size as the conductors of the outside legs.

Supply conductors from the electric generating set to the junction box on the compartment wall must be installed in flexible conduit.

CAUTION

Do not use solid metal conductors in compartment. They may develop metal fatigue from set movement and eventually break.

WARNING

Because of fire hazard, do not tie electrical wiring to fuel line.

DISCONNECT SWITCH

The feeder conductors from the set compartment must terminate in a double-pole, double-throw positive off switch device for 120 volt operation before the vehicle distribution panel. This assures the outside power source cannot be connected simultaneously with the electric generating set. For

120/240 volt operation, a 3-pole, double-throw, positive off, switching device must be used. Neutral must be switched.

RECOMMENDED TRANSFER MECHANISMS

An economical manual, positive-off transfer mechanism is a receptacle for the generator set in the compartment. An approved power cable connected from the load, plugs into this receptacle or the park utility power receptacle. This ensures both sources are NOT connected simultaneously.

An alternative to the receptacle is a manual, positive-off type transfer switch. The positive-off switch allows residual voltages of inductive loads (motors, etc.) to decay before switching to the other power source.

WARNING

Use only approved power supply assemblies. Never remove grounding pin from power supply assembly. Incorrect or no ground may cause the recreational vehicle to be electrically "hot."

RECONNECTIBLE, SINGLE-PHASE GENERATOR

Voltage selection on reconnectible single-phase generators is for use as 120/240 volts, 3 wire; or 120 volts, 2 wire. Use the connection for two wire service when used for motor starting such as air conditioning. Balance the load when connecting for three wire service. Current for any one output lead must not exceed nameplate rating. When two or more single-phase circuits are available, divide the load equally among them. See Figure 12.

LOAD CONNECTIONS

Generator set load wires M1, M2, M3 and M4 terminate within the junction box. Connect and join wires within junction box in an approved manner for desired voltage code. See Figure 12.

On motor homes which have provisions for using outside AC utility power (separate from the electric generating set) the neutral as well as the "Hot" lead MUST be completely isolated from the motor home when load or power is switched.

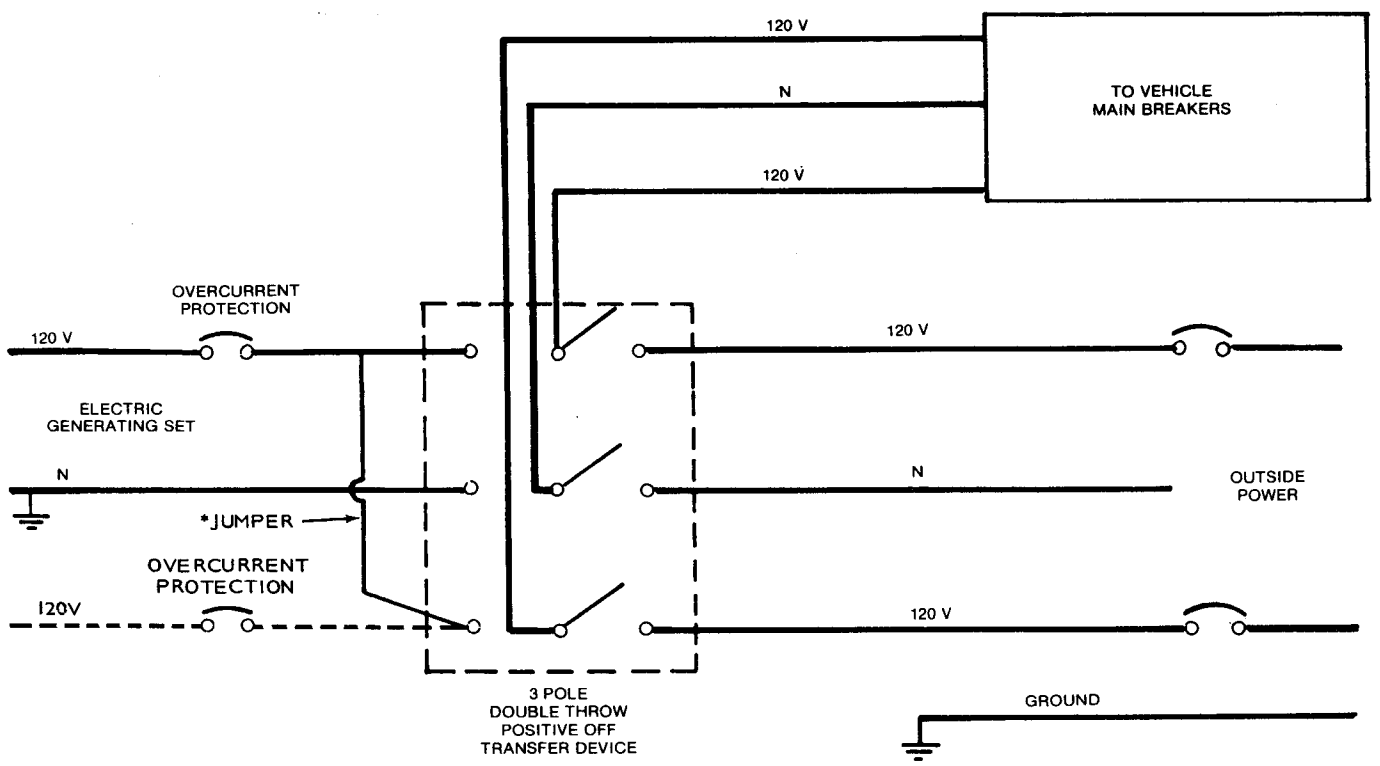
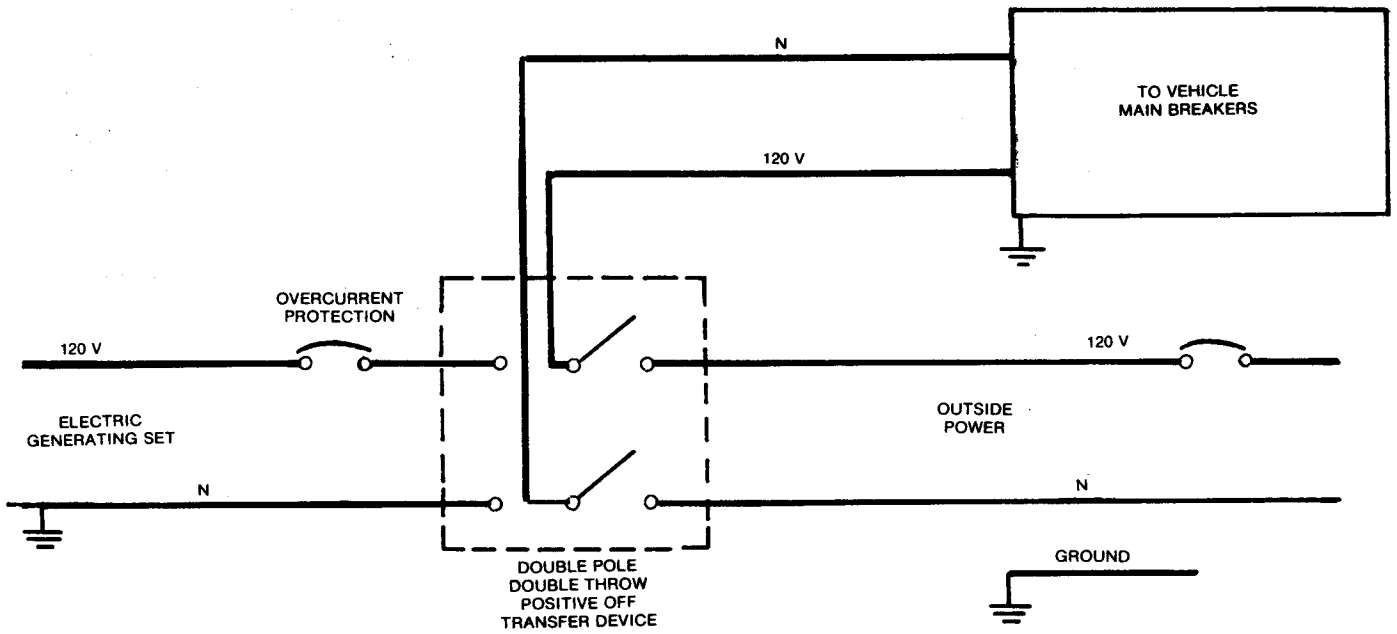

*FOR 120/240 OPERATION DO NOT USE JUMPER. CONNECT OVERCURRENT PROTECTION AS SHOWN IN DASHED LINE. SEE RECONNECTION DIAGRAM: FIG. 12

Figure 11. SCHEMATIC OF TRANSFER DEVICE AND OVERLOAD PROTECTION

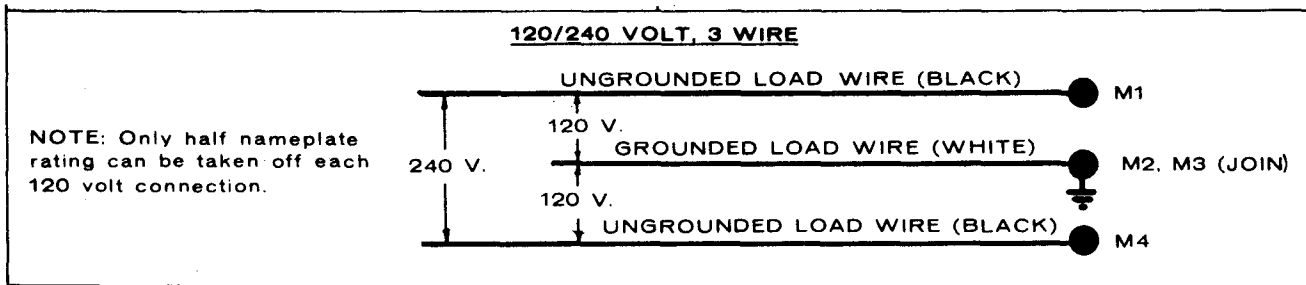
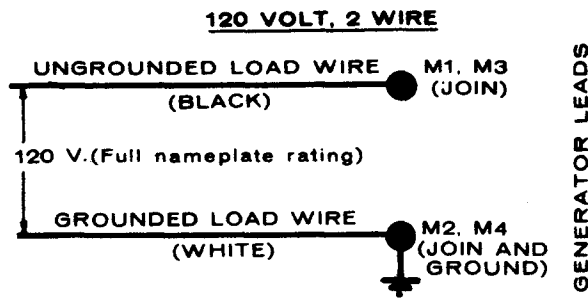

FIGURE 12. SINGLE-PHASE, "3C" VOLTAGE CODE GENERATOR CONNECTIONS

The operation of a typical transfer device is shown in Figure 11. In addition to the transfer device, an over current protection device (circuit breaker or fuse) shall be provided between the transfer device and the AC circuit in the motor home. The generator set field has inherent overload protection when any overload is applied; frequency will sag which causes output voltage to drop and in turn the generator set field drops to zero voltage. A ground fault circuit interrupter should be installed in the wiring system to protect all branch circuits.

WARNING Use only approved power supply assemblies. Never remove grounding pin from power supply assembly. Incorrect or no ground may cause the recreational vehicle to be electrically "hot."

STARTING CONTROLS

Remote control Onan electric sets are designated by an "R" in the model number and provide the operator to start the set inside the vehicle, etc. Sets with the designation "E" are electric start at the set only. See the appropriate operator's manual for more specific information.

Onan has available remote start-stop controls for the AJ, LK, BF, CCK and NH electric generating sets. An Onan remote control switch shown in Figure 13 includes a start-stop switch with an amber indicator lamp (lights when set is running). A deluxe remote control includes a start-stop switch with an amber indicator lamp (lights when set is running), a running time meter and a battery condition meter. See Figure

14

FRONT SIDE OF REMOTE CONTROL SWITCH

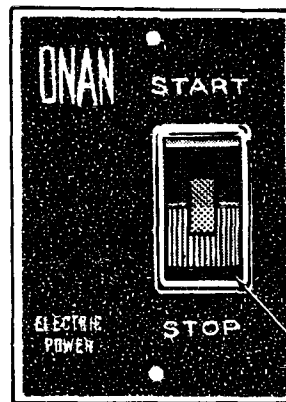

NOTE: Use 18 gauge or larger wire for installing the remote start switch.

STOP-START SWITCH (DPDT)
(Amber light glows when generator set is running)

FIGURE 13 OPTIONAL REMOTE CONTROL SWITCH

FINAL CHECK-OUT PROCEDURE (60 to 80 F ambient)

Before the generator set is operated, remove the spark plug wires so the set will not start when cranked. Connect a voltmeter to the battery terminals, and to the battery side of the start solenoid and set frame as shown in Figure 15.

Crank the engine and measure the voltage at the

battery. Then measure the voltage from the start solenoid to the set frame. Do not allow more than five seconds between these readings (use double-pole, double-throw switch as shown).

Subtract voltage at set from measured battery voltage during the cranking. The difference should not exceed 0.6 volt. If it does, check all connections. A separate ground cable may have to be used (same size as battery cable).

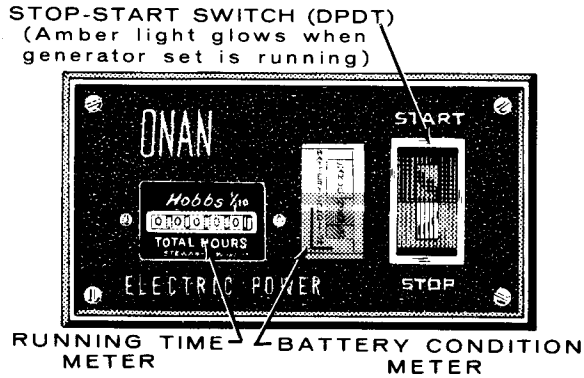

Alternate Test

Remove the spark plug wires, crank the engine and measure the cranking speed. Connect a separate ground cable from the battery to the set's frame. Crank the engine and again measure the speed. If cranking speed increased more than ten percent, check connections and consider a permanent ground cable if it seems necessary.

FIGURE 14. OPTIONAL DELUXE REMOTE CONTROL

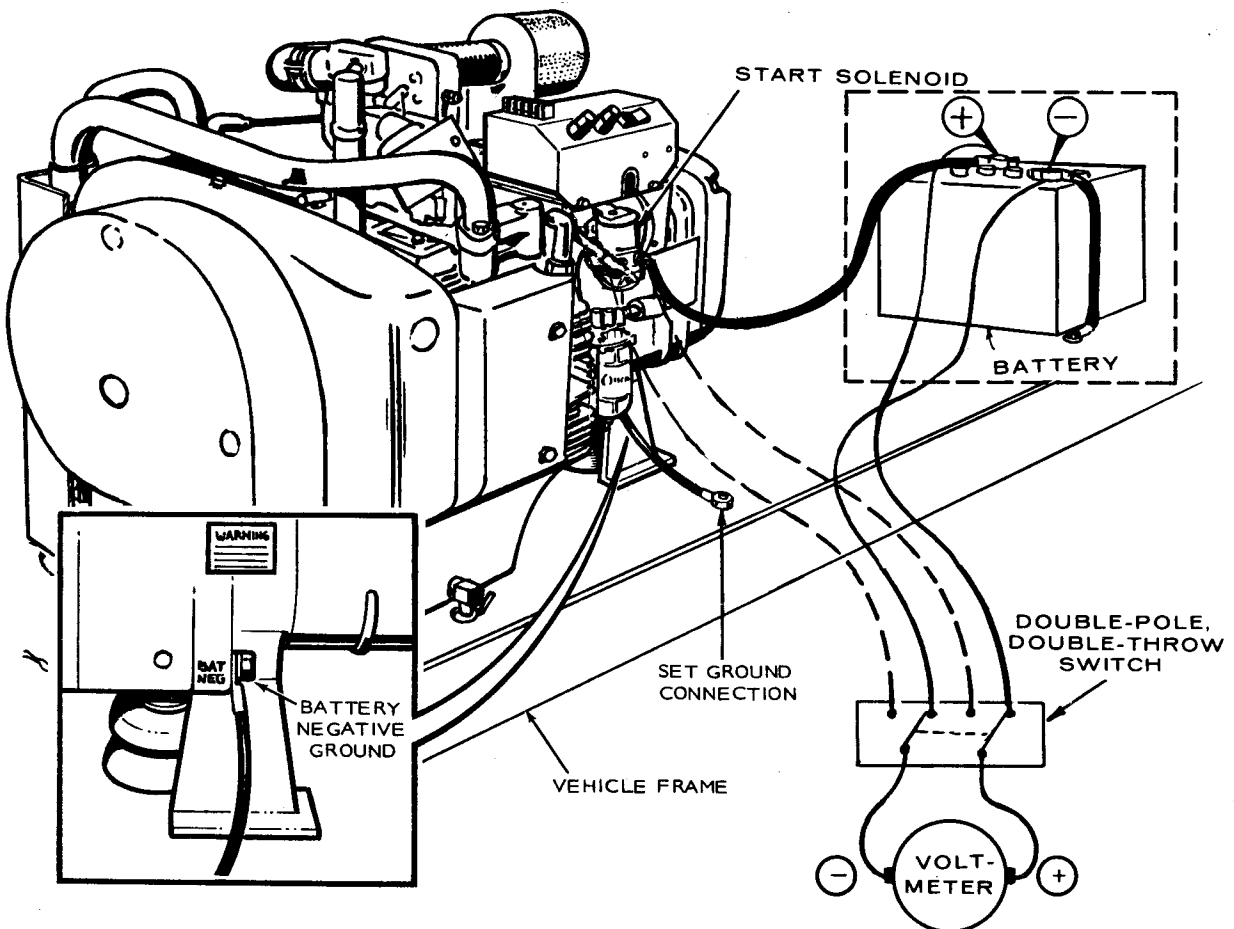

FIGURE 15. BATTERY SYSTEM CHECK-OUT CONNECTIONS

Batteries

BATTERY CARE

To increase battery life, the operator can perform a number of routine checks and some preventive maintenance.

1. Keep the battery case clean and dry.
2. Make sure the battery cable connections are clean and tight. Use a terminal puller when removing cables for any reason.
3. Coat the battery terminals with a mineral grease or petroleum jelly to reduce corrosion and oxidation.
4. Identify each battery cable to be positive or negative before making any connection. Always connect the ground (negative) cable last.
5. Maintain the electrolyte level by adding water (drinking quality or better) as needed for filling to split level marker. (The water ingredient of the electrolyte evaporates, but the sulphuric acid ingredient remains. Therefore, add water, not electrolyte.)
6. Avoid overcharging when recharging. Stop the boost charge when the specific gravity is 1.260 and the electrolyte is 80°F (26.7°C).

WARNING Do NOT use unvented batteries with this generator set. Malfunction of the starting-charging system can produce high charging currents, causing excessive gassing. An unvented battery can build up sufficient pressure to explode.

BATTERIES AND BATTERY CABLES

In order for the electric generating set to crank efficiently under various operating conditions, the battery and battery cables must be correctly chosen and installed. Before selecting a battery, be sure the installation area is compatible and properly designed. The compartment for the battery must provide:

1. Rigid mounting support.
2. A location where accidental acid spills or leaks won't damage set, battery cables, etc.
3. Provide a minimum of 2 square inches at top and 2 square inches at bottom of battery for ventilation purposes.

WARNING Do not disconnect battery cables from battery while generator set is cranking or running; sparks may cause an explosion.

WARNING Mount the battery in a separate compartment from the set or any spark-producing device to prevent fire or explosion.

CAUTION

Never disconnect the battery with either engine running and never crank both engines

simultaneously.

Battery Cables

For reliable starting, voltage drop from the battery terminals to the exciter cranking windings of the generator should not exceed 0.12 volts per 100 amperes of break-away current. The battery cables in Table 7 will meet this condition if the grounding system is adequate. Connect the battery negative to ground with the same size cable as used for battery positive.

Be sure the frame connection (major frame member if possible) is sufficient to minimize resistance. Try to avoid a connection at a weld or mechanical joint.

For short distances, one negative battery cable can be used between set and battery rather than separate cables to chassis ground.

Battery Selection

Determine battery size by the amount of "surge" power required to start the generating set. Select a battery that is at least as large as that specified by Onan.

Locate battery as close as possible to starter and charging system. Keep the battery well charged and clean. Keep terminals clean and free of corrosion.

Battery Size

Onan recommends one 12-volt, 74 amp hour battery for all RV generator sets. In colder temperature applications (0° to 32°F), one 12-volt, 92 amp hour battery is recommended for all units. For sub-zero operation, Onan recommends one 12-volt, 105 amp or larger capacity battery.

**TABLE 7.
RECOMMENDED BATTERY CABLES**

* CABLE LENGTH IN FEET (metres)	CABLE SIZE
0-10 (0-3)	2
11-15 (3-4.5)	0
16-20 (4.5-6)	000

* - Distance from battery to set.

Remote Accessories

INSTALLING STANDARD REMOTE CONTROL

This control includes a start-stop switch with an indicator lamp. Install as follows:

1. Select switch location. Using Figure 16 as a guide, drill screw holes and cut holes in RV panel.
2. Following national and local electrical codes and using four insulated wires of predetermined length (#18 or larger), connect remote switch to terminals on generator. See Figure 17.

CAUTION Ensure that leads from remote switch connect with corresponding terminals on generator terminal board.

CAUTION Don't route DC wires for remote control through conduit containing AC load wiring. Induced voltages may cause erratic operation.

3. Insert remote switch in hole cutout and secure with two #5 woodscrews supplied with switch.

WARNING Seal all holes that might allow noxious gases from generator set into motor home.

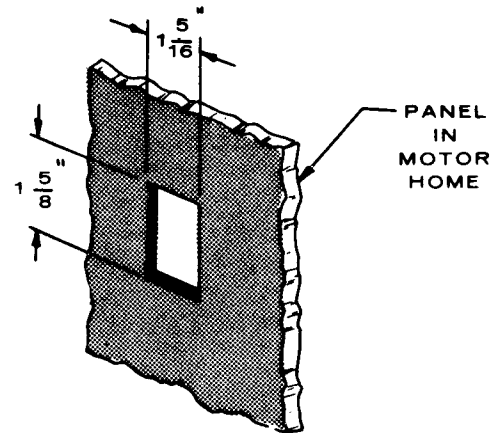

FIGURE 16. MOTOR HOME CUTOUT

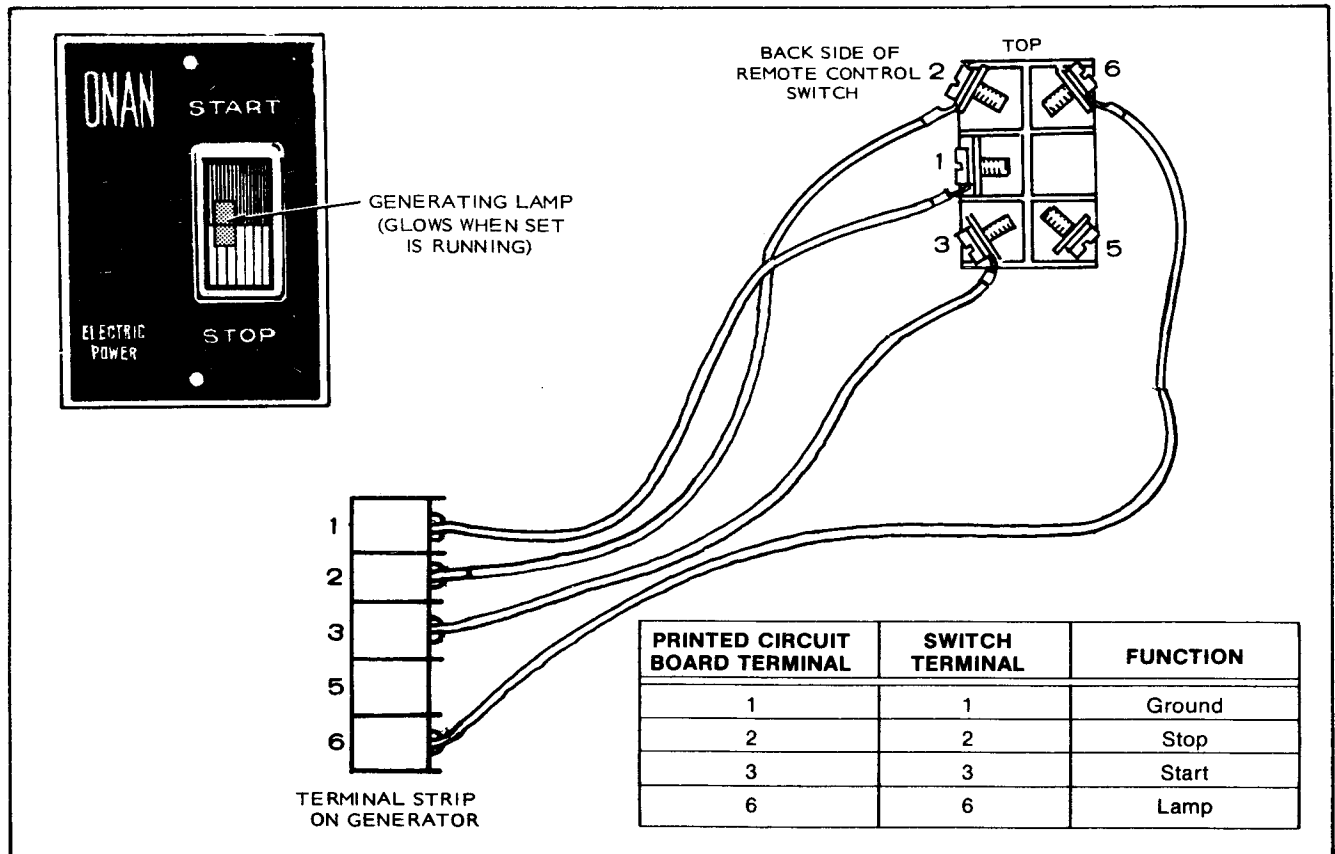

FIGURE 17. CONNECTING REMOTE CONTROL (300-0985)

INSTALLING DELUXE REMOTE CONTROL

This control includes a start-stop switch with an indicator lamp, a running time meter and a battery condition meter. Install and connect as follows:

1. Select control location. Using Figure 18 as a guide, drill screw holes and cut hole to accommodate remote switch in panel.
2. Following national and local electrical codes and using five insulated wires of predetermined length (#18 or larger), connect remote control to terminals on generator. Ensure that leads from remote control connect to corresponding terminals on generator terminal board. See Figure 19.

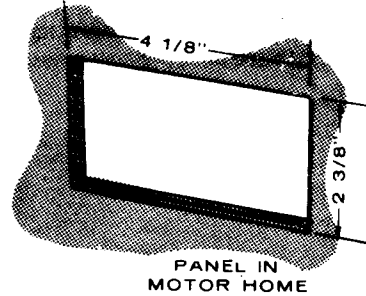

FIGURE 18. MOTOR HOME CUTOUT

CAUTION Don't route DC wires for remote control through conduit containing AC load wiring. Induced voltages may cause erratic operation.

3. Insert remote control in hole cutout and secure with four #5 woodscrews supplied with switch.

WARNING Seal all holes that might allow noxious gases to enter motor home.

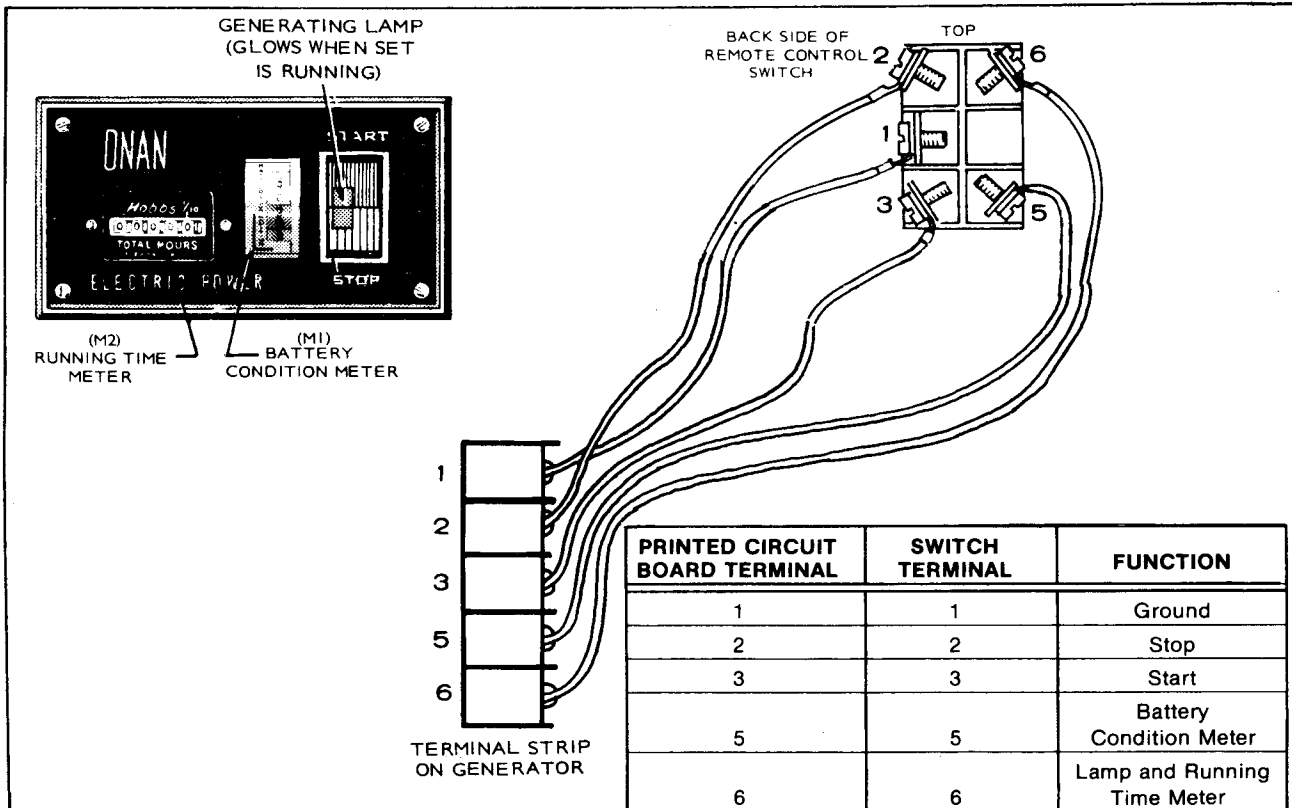

FIGURE 19. CONNECTING DELUXE REMOTE CONTROL (300-0986)

Pre-Start Checks

The RV unit is complete as received except for exhaust components and any other optional accessory items which are shipped loose with each set for installation later. After the initial installation is completed, the following steps are necessary before actually starting the generator set for the first time.

1. Install the exhaust system.
2. Add oil to the engine.
3. Connect fuel line to engine from fuel supply tank.
4. Connect electrical leads to load circuits.
5. Connect the start stop remote switches (if used).
6. Connect battery leads between set and battery. Connect ground lead last.

Vehicle chassis (frame) ground and the battery and generator set ground should all be electrically connected to be at 0 ground potential. All Onan units are designed for negative ground application.

FUEL SYSTEM

With set running, check for leaks. Raw fuel will cause

fumes which could EXPLODE. Check around carburetor and fuel pump inlets. Make sure fuel lines are not rubbing against anything which could cause breakage.

ELECTRICAL

AC Output

All AC leads (M1, M2, M3 and M4) terminate in generator set's junction box. These wires should be connected to distribution box with multistrand wire enclosed in a flexible conduit. Check all wires (to and from the generator set) for fraying and loose connections.

Battery Connections

Battery positive (+) connects to start solenoid. Battery negative (-) connects to location on rear of generator. Check terminals on set for clean and tight connections.

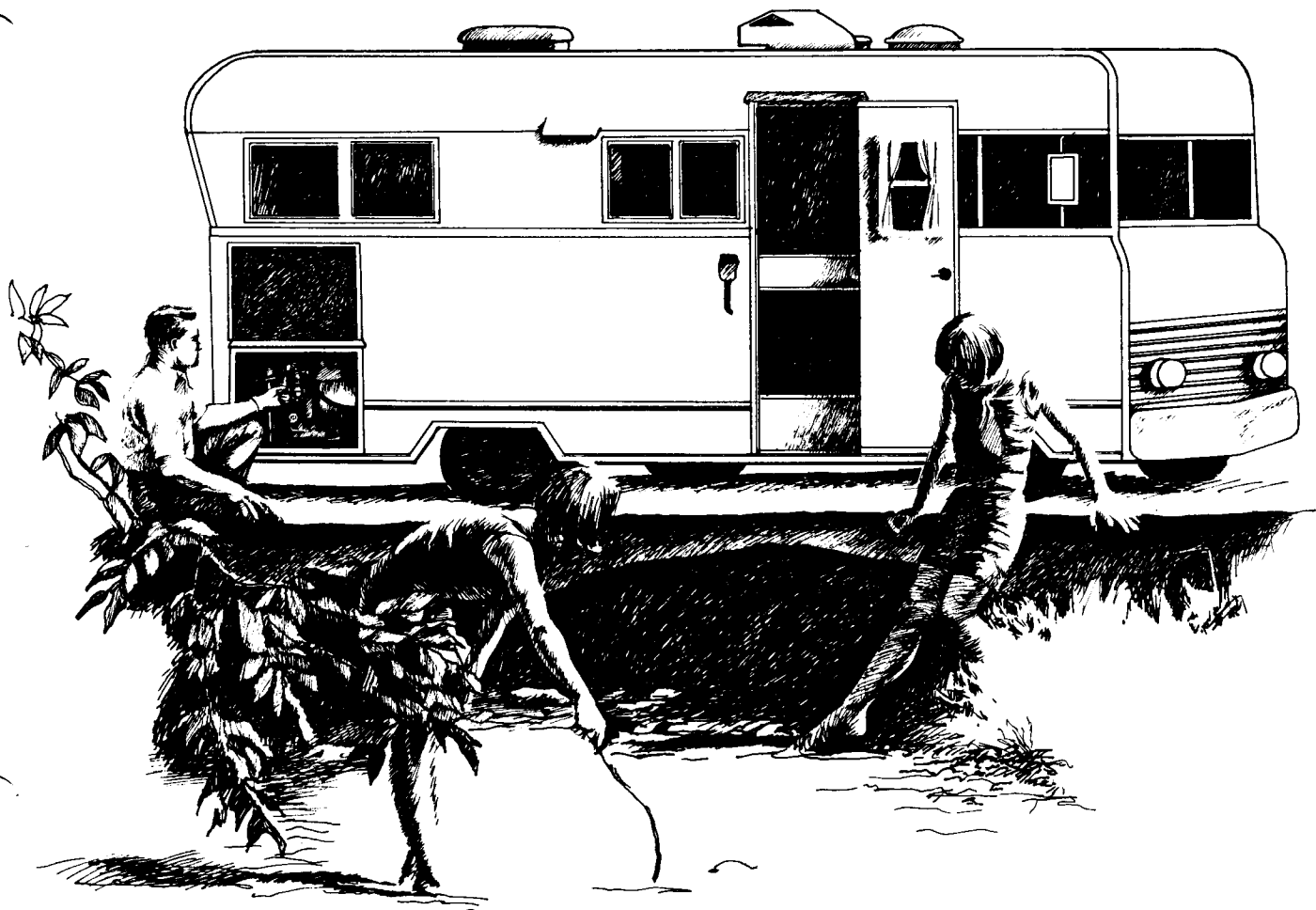

WHAT IS A GOOD INSTALLATION?

An owner of an RV electric generating set considers his unit well installed if it produces electricity quietly, reliably and efficiently.

But how do you — the installer — provide a good installation? Here are some guidelines:

The electric generating set should be mounted on vibration isolators and the isolators, in turn, firmly mounted to a strong base. The fuel and electrical lines should be mounted to the frame and connected to the unit through flexible sections. Exhaust system components must be installed with good automotive practice.

Cooling is important. All good RV installations call for a well-ventilated generator compartment (see section on *Ventilation*), one that cools adequately while running and completely purges heated air after shutdown.

A good installation must also be fireproof and vapor-proof. This bulletin tells how to accomplish this . . . read it carefully.

Our recommendations for the proper installation of an RV electric generating set are based on years of experience in the manufacture of generator sets. We offer these recommendations through this technical bulletin so you can be assured the Onan unit selected for your recreational vehicle will operate quietly and efficiently for many years to come.

Onan manufactures a complete line of electric power systems from 1 to 750 kW (generator sets • automatic transfer switches • industrial engines), gas-, gasoline- or diesel-driven. For standby power in homes, industrial plants, commercial buildings and institutions. For auxiliary or portable power in boats, recreational vehicles, service trucks and construction equipment.

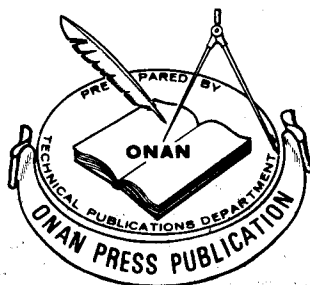

T-017

technical bulletin

RATING FACTORS FOR ELECTRIC GENERATING SETS

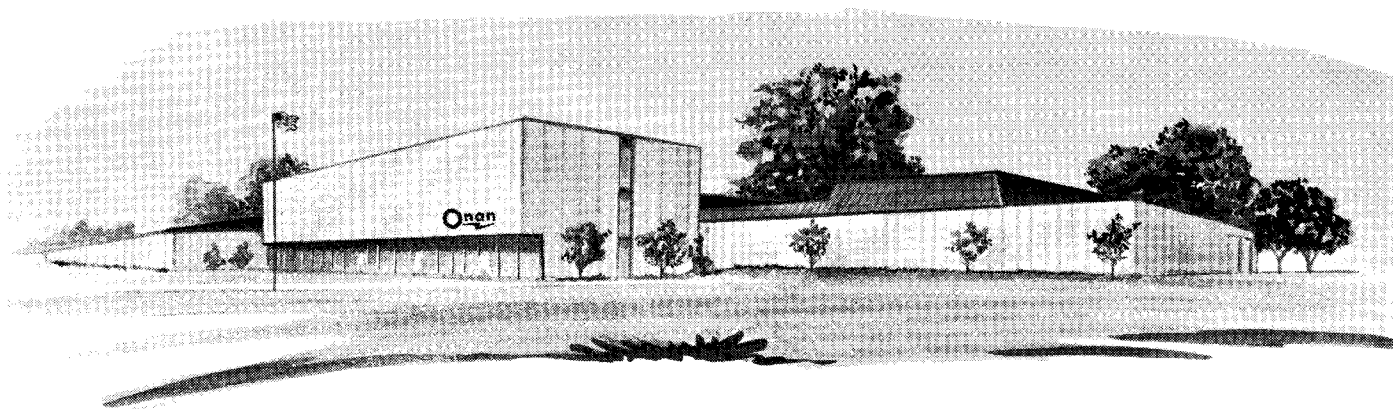

ONAN

1400 73RD AVENUE N.E. • MINNEAPOLIS, MINNESOTA 55432
A DIVISION OF ONAN CORPORATION

Printed in U.S.A.

APRIL 1974

INTRODUCTION

Ratings of electric generating sets and operating conditions must be studied and considered before a unit is selected for a particular installation. Under some conditions, many considered normal, a generating set could fall short of the requirements if certain operating factors are overlooked. Read through the bulletin and follow the examples on selecting a generating set.

FACTORS AFFECTING GENERATING SET OUTPUT

Engine power and generator capabilities determine output of a generating set. A main factor affecting output is the ratio of engine power to power required by the generator. Engines with considerable reserve horsepower are only slightly affected by a small loss of engine efficiency. If the engine must operate near its maximum rated power output, any engine power loss will also result with a generator output loss.

Among the variable factors affecting generating set output is —

- Fuel
- High Altitude
- High Ambient Temperature

If any one condition affects engine power enough, the rating of the generating set has to be lowered or "derated." Each of these conditions is discussed separately.

Fuel

All Onan generating sets are normally rated on their standard fuel capability. However, most Onan gasoline-fueled generating sets are adaptable for use with gaseous fuel. Gas fuel, LP, natural or manufactured, can be specified and greatly affects engine power developed. An engine will develop nearly the same horsepower using LP gas as when using gasoline. But for natural or manufactured gas, derating is usually larger. See Table 1.

Ratings for the different fuels in Table 1 are based on regular-grade gasoline, 2500 BTU/cu. ft. propane, 1000 BTU/cu. ft. natural gas, and number 2 diesel fuel. Note some engines have higher maximum KW potentials as high compression engines. Generally, propane and natural gas allow higher compression ratios.

High Altitude

From a practical viewpoint, altitude derating of any Onan generating set is unnecessary at altitudes below 1000 feet. Onan units are rated for conditions at the factory where the altitude is approximately 900 feet. However, lower density air at higher altitudes can cause lower engine power and lower generator cooling capabilities. The degree of power loss varies from engine to engine, but as a general rule, derate about 4 percent for each 1000 feet increase in altitude.

High Ambient Temperature

When an engine is operating in hot air ambients, the engine suffers a proportionate power loss because hot air is less dense than cool air (similar to higher altitude). An average derating value of 1 percent loss for each 10 F above 60 F is used, disregarding the fact summer ambient temperature for the factory test run is frequently well above 80 F. Derating for higher temperature only is seldom required . . . usually done in combination with other derating factors or in borderline cases.

Because life of some engines is shortened when run continuously at rated load for long periods of time, some are derated for prime power installations. This is especially true when the engine does not have a large horsepower reserve for a given generator size. Contact your Onan distributor.

DETERMINING GENERATING SET RATING Engine

1. Find the maximum KW potential of the engine for the appropriate fuel in Table 1.

For city-water cooling, add KW shown in the first column to the engine KW potential (based on deduction of fan horsepower).

2. Use the altitude derating percentage from Table 2 or 3 (if over 1000 feet) and add to the following temperature derating, if any.
3. Derate the engine 1 percent for each 10 F above 60 F ambient temperature.
4. Total the derating percentages for altitude and temperature. Subtract this total from 100 percent and multiply this percentage times the maximum KW from Step 1.

TABLE 1. MAXIMUM KW POTENTIAL OF ENGINE ONLY*

SPARK IGNITION				
Air Cooled Series	—	Gasoline	Propane	Nat. Gas
2.5LK		2.6	2.5	2.1
2.5AJ		2.5	2.4	2.3
4.0CCK		5.5	5.4	5.0
5.0CCK		5.5	5.4	5.0
6.5NH		7.0	6.0	5.0
7.5JB		8.0	7.8	7.5
10.0CCKB		10.2	9.5	8.0
12.5JC		17.0	16.0	13.5
15.0JC		17.0	16.0	13.5
		—	—	15.0 §
Liquid-Cooled Series	Add this KW for City-Water Cooling	Gasoline	Propane	Nat. Gas
12.5RJJC		17.0	16.5	16.0
15.0RJJC		17.0	16.5	16.0
30.0EK		33.0	31.0	28.0
45.0EM		48.0	45.0	39.0
55.0KB	3.0	65.0	58.0	52.0
65.0KB	3.0	65.0	—	—
70.0KR	3.0	—	—	77.0
85.0KR	4.0	93.0	85.0	77.0
	4.0	—	—	80.0 †
115.0WA	3.0	120.0	119.0	118.0
170.0WB	10.0	185.0	180.0	174.0
	10.0	—	—	180.0 †
250.0FT	10.0	—	—	260.0
350.0WF	20.0	—	—	390.0
400.0WK	20.0	—	—	480.0

DIESEL		
Air-Cooled Series	—	Diesel
3.0DJA		3.2
6.0DJB		6.7
12.0DJC		13.4
Liquid-Cooled Series	Add this KW for City-Water Cooling	Diesel
15.0RDJC		15.7
17.5RDJF		17.5
30.0DEH		33.0
30.0DDA		30.0
45.0DEF		53.0
45.0DYJ		45.0
50.0DDA		50.0
50.0DEG		55.0
60.0DYA	1.1	66.0
75.0DYC	3.5	95.0
90.0DYC	3.5	95.0
100.0DYD	4.0	131.0
125.0DYD	4.0	131.0
150.0DYG	6.0	183.0
175.0DYG	6.0	183.0
200.0DYH	6.0	207.0
250.0DYB	7.5	260.0
300.0DFT	5.0	300.0
350.0DFU	5.0	370.0
400.0DFV	5.0	405.0
450.0DFW	13.0	485.0
500.0DFY	10.0	520.0

* - Maximum engine KW capability with no deratings for altitude or temperature. Ratings shown are for 60 hertz. Use 83% of these ratings for 50 hertz.
 § - This value obtained with high compression engine (do not use propane).
 † - This value obtained with high compression engine.

For prime power ratings or application problems, contact your Onan distributor.

Generator

Find the altitude deration in Table 4. Multiply the percentage shown in "°% of Standard Rating (KW)" column times the generating set rating. This figure is the maximum generator KW.

Actual Generating Set Capacity

Find the lower KW capability from "Engine" and "Generator." This figure is the actual unit rating for that particular application. See the following examples.

TABLE 2. GASOLINE, PROPANE AND DIESEL ENGINE ALTITUDE DERATINGS

Altitude Above Sea Level	% of Standard Rating (KW)	% Deration per 1000 ft	Total % Deration
1000	100 %	0	0
2000	95.5	4.5	4.5
3000	91	4.5	9.0
4000	87.5	4.1	12.5
5000	84	4.0	16.0
6000	80	4.0	20.0
7000	76	4.0	24.0
8000	72	4.0	28.0
9000	69.5	3.8	30.5
10000	67	3.7	33.0

EXCEPTION: Derating is unnecessary through 5000 feet for series DYA, DYB, DYC, DYD, DYG, DYH, DFU, DFV, DFW and DFY. Use only additional altitude when calculating.

TABLE 3. NATURAL GAS ENGINE ALTITUDE DERATINGS

Altitude Above Sea Level	% of Standard Rating (KW)	% Deration per 1000 ft	Total % Deration
1000	100 %	0	0
2000	93.6	6.4	6.4
3000	87.9	6.0	12.1
4000	82.7	5.7	17.3
5000	77.9	5.5	22.1
6000	72.5	5.5	27.5
7000	67.2	5.4	32.8
8000	62.2	5.4	37.8
9000	58.6	5.2	41.4
10000	55.9	4.9	44.1

TABLE 4. GENERATOR ALTITUDE DERATINGS

Altitude Above Sea Level	% of Standard Rating (KW)	% Deration per 1000 ft	Total % Deration
1000	100 %	0	0
2000	100	0	0
3000	100	0	0
4000	97	3	3
5000	94	3	6
6000	91	3	9
7000	88	3	12
8000	85	3	15
9000	82	3	18
10000	79	3	21

NOTE: Derate from standby ratings as shown on charts, specification sheets or unit's nameplate.

Onan manufactures a complete line of electric power systems from 1 to 500 KW (generator sets • automatic transfer switches • industrial engines), gas-, gasoline- or diesel-driven. For standby power in homes, industrial plants, commercial buildings and institutions. For auxiliary or portable power in boats, recreational vehicles, service trucks and construction equipment.

